

Version
2.1.20

NEC
Display Wall Calibrator

Powered by



User's Guide

Software Updates

Occasionally, updates and enhancements to the *NEC Display Wall Calibrator* software will be made available. Visit the *NEC Display Wall Calibrator* section of the Sharp NEC Display Solutions website to check for availability, or use the *Check for updates* feature in the software to automatically see if a newer version is available.

Sharp NEC Display Solutions welcomes feedback and suggestions for product improvements. Please use the feedback form on the *NEC Display Wall Calibrator* section of the Sharp NEC Display Solutions website.

Technical Support and Feedback

For technical support with the *NEC Display Wall Calibrator* product, please visit the *NEC Display Wall Calibrator* section of the Sharp NEC Display Solutions website and check for any Frequently Asked Questions that may help to solve the issue. An online feedback form is available for submitting questions and feedback.

Trademarks and Copyright

Microsoft and Windows are either registered trademarks or trademarks of Microsoft Corporation in the United States and/or other countries.

Apple, Macintosh, macOS, Mac and the Mac logo are trademarks of Apple Computer, Inc., registered in the U.S. and other countries.

Adobe, the Adobe logo, Acrobat, the Adobe PDF logo, Distiller and Reader are either registered trademarks or trademarks of Adobe Systems Incorporated in the United States and/or other countries.

SpectraView is a registered trademark of Sharp NEC Display Solutions of America, Ltd.

Copyright © 2021 Sharp NEC Display Solutions, Ltd.

The content of this manual is furnished for informational use only, is subject to change without notice, and should not be construed as a commitment by Sharp NEC Display Solutions, Ltd. Sharp NEC Display Solutions, Ltd. assumes no responsibility or liability for any errors or inaccuracies that may appear in this manual.

All rights reserved. Your rights of ownership are subject to the limitations and restrictions imposed by the copyright laws as outlined below.

It is against the law to copy, reproduce or transmit, including without limitation electronic transmission over any network, any part of the manual except as permitted by the Copyright Act of the United States, Title 17, United States Code. Under the law, copying includes translation into another language or format.

The above is not an inclusive statement of the restrictions imposed on you under the Copyright Act.

For a complete statement of the restrictions imposed on you under the copyright laws of the United States of America, see Title 17, United States Code.

USA and Canada: www.sharpnecdisplays.us

Europe: www.sharpnecdisplays.eu

Asia Pacific: www.sharp-nec-displays.com/ap

Revision 210125

HARDWARE LIMITED WARRANTY (U.S.A. and Canada Only)

SHARP NEC DISPLAY SOLUTIONS warrants the NEC Display Wall Calibrator "Color Sensor" Hardware (hereinafter "Product" or "Products") to be free from defects in material and workmanship and, subject to the conditions set forth below, agrees to repair or replace (at SHARP NEC DISPLAY SOLUTIONS's sole option) any part of the enclosed unit which proves defective for a period of one (1) year from the date of first consumer purchase. Spare parts are warranted for ninety (90) days. Replacement parts or unit may be new or refurbished and will meet specifications of the original parts or unit.

This warranty gives you specific legal rights and you may also have other rights, which vary from state to state. This warranty is limited to the original purchaser of the Product and is not transferable. This warranty covers only SHARP NEC DISPLAY SOLUTIONS-supplied components. Service required as a result of third party components is not covered under this warranty. Service required as a result of abuse or improper usage is also not covered under this warranty. In order to be covered under this warranty, the Product must have been purchased in the U.S.A. or Canada by the original purchaser. This warranty only covers Product distribution in the U.S.A. or Canada by SHARP NEC DISPLAY SOLUTIONS No warranty service is provided outside of the U.S.A. or Canada. Proof of Purchase will be required by SHARP NEC DISPLAY SOLUTIONS to substantiate date of purchase. Such proof of purchase must be an original bill of sale or receipt containing name and address of seller, purchaser, and the serial number of the product.

SHARP NEC DISPLAY SOLUTIONS SHALL NOT BE LIABLE FOR DIRECT, INDIRECT, INCIDENTAL, CONSEQUENTIAL, OR OTHER TYPES OF DAMAGES RESULTING FROM THE USE OF ANY SHARP NEC DISPLAY SOLUTIONS PRODUCT OTHER THAN THE LIABILITY STATED ABOVE. THESE WARRANTIES ARE IN LIEU OF ALL OTHER WARRANTIES EXPRESS OR IMPLIED, INCLUDING, BUT NOT LIMITED TO, THE IMPLIED WARRANTIES OF MERCHANTABILITY OR FITNESS FOR A PARTICULAR PURPOSE. SOME STATES DO NOT ALLOW THE EXCLUSION OF IMPLIED WARRANTIES OR THE LIMITATION OR EXCLUSION OF LIABILITY FOR INCIDENTAL OR CONSEQUENTIAL DAMAGES SO THE ABOVE EXCLUSIONS OR LIMITATIONS MAY NOT APPLY TO YOU.

This Product is warranted in accordance with the terms of this limited warranty. Consumers are cautioned that Product performance is affected by system configuration, software, the application, customer data, and operator control of the system, among other factors. While SHARP NEC DISPLAY SOLUTIONS Products are considered to be compatible with many systems, specific functional implementation by the customers of the Product may vary. Therefore, suitability of a Product for a specific purpose or application must be determined by consumer and is not warranted by SHARP NEC DISPLAY SOLUTIONS.

Federal Communications Commission (FCC) Notice (U.S.A. Only)

WARNING: This equipment has been tested and found to comply with the limits for a Class B digital device, pursuant to Part 15 of the FCC Rules. These limits are designed to provide reasonable protection against harmful interference in a residential installation. This equipment generates, uses, and can radiate radio frequency energy and, if not installed and used in accordance with the instructions, may cause harmful interference to radio communications. However, there is no guarantee that interference will not occur in a particular installation. If this equipment does cause harmful interference to radio or television reception, which can be determined by turning the equipment off and on, the user is encouraged to try to correct the interference by one or more of the following measures:

- Reorient or relocate receiving antenna.
- Increase the separation between the equipment and receiver.
- Connect the equipment into an outlet on a circuit different from that to which the receiver is connected.
- Consult the dealer or an experienced radio/TV technician for help.

This device complies with Part 15 of the FCC rules. Operation is subject to the following two conditions:

- This device may not cause harmful interference.
- This device must accept any interference received including interference that may cause undesired operation.

Contents

	Precautions	7
	Supported Display Monitors	8
	System Requirements	13
	What's new in this version	14
Chapter 1	Introduction	15
	Overview	15
	Main Features and benefits	16
	About SpectraView Engine (SVE)	17
Chapter 2	Calibration Overview	19
	Introduction to display monitor calibration	19
	About Calibration Targets	19
	Intensity	20
	White Point	21
	Gamma and Tone Response Curves (TRC)	21
	Contrast Ratio	22
	Calibration Steps	23
	Calibration Projects	24
	Analog Video Inputs - Important Notice	24
Chapter 3	Planning and Configuring a Wall Layout	25
	Planning	25
	Physical Considerations	25
	Configuring Connections	27
	Direct LAN	27
	RS232 Daisy-chain	28
	LAN Daisy-chain	28
	Using the Auto ID function with a LAN daisy-chain	30
	Using DHCP (Dynamic Host Configuration Protocol)	30
	Example: Daisy-chained RS232 with one COM port	31
	Example: Daisy-chained RS232 with multiple COM ports	32
	Example: Single IP LAN with daisy-chained RS232	33
	Example: Direct Multi IP LAN	35
	Example: Multi IP LAN using LAN daisy-chain	37
	Example: RS232 using LAN daisy-chain	40
	Connecting to displays wirelessly	41
	Configuring a Layout with the Layout Wizard	42
	Calibration Order	50
	Calibration Times	51
	Video Inputs	52
Chapter 4	Dialogs, Settings and Menus	53
	Main NEC Display Wall Calibrator window	53
	Scale Main View	54
	Main window context menu	55
	Display Information ToolTip	55
	Edit Calibration Target Configuration dialog	56
	Custom Gamma Curve dialog	58
	Custom White Point dialog	59
	Preferences dialog	60
	Preferences dialog - Calibration Sensor panel	60
	Preferences dialog - Calibration Method panel	62
	Preferences dialog - Advanced panel	68
	Preferences dialog - Updates panel	69
	Preferences dialog - Interface panel	70
	Panels	72

	Actions panel	72
	Display Control panel	74
	Connection panel	74
	Colorimeter panel	75
	Test Pattern panel	75
	Reset/Restore panel	76
	Display Measurements panel	76
	Calibration Target panel	77
	Tile Matrix Wizard dialog	78
	Calibration Target Offset	80
	Display Settings dialog	82
	Display Settings dialog - Power panel	82
	Display Settings dialog - Cooling panel	84
	Display Settings dialog - Video panel	85
	Display Settings dialog - Tile Matrix panel	88
	Display Settings dialog - IR Remote panel	90
	Display Settings dialog - OSD panel	91
	Display Settings dialog - Group ID panel	92
	Display Settings dialog - Status panel	93
	Display Settings dialog - Analog Video panel	94
	Display Settings dialog - Clock panel	96
	Display Settings dialog - Schedule (Basic) panel	97
	Display Settings dialog - Schedule (Advanced) panel	98
	Summary window	100
	Menus	103
	File menu	103
	Edit menu	103
	View menu	103
	Tools menu	104
	Help menu	104
Chapter 5	Quick Start Guide	105
Chapter 6	Frequently Asked Questions	108
	Configuration	108
	Calibration	108
Chapter 7	Troubleshooting	110
	Installation and Setup	110
	Calibration	111
	Color Sensor	111
Chapter 8	Visual Trim function	113
	Visual Trim (calibrated without SpectraView Engine)	114
	Visual Trim (calibrated with SpectraView Engine)	115
	Overall Screen Color correction	115
	Overall and Corner Uniformity correction	116
Chapter 9	Update Uniformity	118
Chapter 10	Update Factory Color Calibration	121
	Performing an Update Factory Color Calibration	122
Chapter 11	Calibrating Without a Color Sensor	123
	Performing a Calibrate Without Using a Color Sensor	124
Chapter 12	Advanced Analog Adjustment function	125
	Overview	125
	Requirements	125
	Adjustment steps	126

Chapter 13	Calibration Method Comparison	129
	Overview	129
Appendix A	Assigning an IP address	131
	Setting the IP address via a web browser	131
Appendix B	Calibration Process Flowcharts - Recommended Procedures	133
Appendix C	Glossary	136

Precautions

- The LCD display monitor screen is fragile and can be easily damaged if force is applied. Even slight forces applied to the screen can cause temporary color distortions that can impact the calibration process.
- Be extremely careful when using suction cups to attach a color sensor to the display.
- Use the supplied cable or sling and counterweight to gently rest the color sensor on the face of the display, or hold gently and steadily against the screen surface by hand, using the minimum possible force.
- Always try and position the color sensor in the center of the screen when taking measurements or calibrating.
- During the display calibration procedure, highly sensitive light measurements are made on the screen using the color sensor. High ambient light levels such as direct sunlight on the screen, may affect measurements and cause an inaccurate display calibration. Changes in ambient lighting can alter how images on the screen are perceived.
- Always store the color sensor in the holder when not in use.
- When using the X-Rite i1Display, the white plastic diffuser must be removed prior to taking any measurements. Replace it when finished to protect the sensor from dust and damage.
- Never touch the measurement window in the color sensor.
- Never disconnect the color sensor while the *NEC Display Wall Calibrator* software is running.
- Always allow the displays to warm up for at least 30 minutes before calibrating.

Note:

- **USB extender cables** - Some models of color sensors may not work properly when using a USB extender cable or when connected via a USB hub device. If problems are experienced with detecting color sensor or taking measurements with the color sensor, try connecting it directly to the host PC.
 - This document covers both the macOS and Windows versions of the software. The majority of the User Interface screen images in this document show the Windows version. The features, functions, and layout of both versions are identical unless otherwise noted.
 - **Analog Video Inputs** - When using analog video inputs on the displays it may be necessary to automatically adjust the video signal levels to compensate for variations in the video signals that may cause color shifts between displays. See the **Analog Inputs - Important Notice** for more information.
-

Supported Display Monitors

Important:

- Newer models not listed may also be supported. See the product information on the Sharp NEC Display Solutions website or product documentation.
- These C-series models are not supported: C431, C501, C551
- E-series models other than those listed below are not supported.

NEC Display Wall Calibrator supports the following NEC display monitor models:

	Connection	Daisy chain	Backlight	Spectra View Engine (SVE) ²	Uniformity Correction	LAN setting by OSD	LAN Power setting	EXTERNAL CONTROL setting	LAN search	Calibrate without a color sensor	Corner Uniformity ²	Update Factory Color Calibration ²	Update Uniformity Correction ²
C651Q	RS232, LAN	LAN	LED	•	•	•	•		•	•	• ³	• ³	• ³
C751Q	RS232, LAN	LAN	LED	•	•	•	•		•	•	• ³	• ³	• ³
C861Q	RS232, LAN	LAN	LED	•	•	•	•		•	•	• ³	• ³	• ³
C981Q	RS232, LAN	LAN	LED	•	•	•	•		•	•	• ³	• ³	• ³
E705	RS232, LAN	N/A	LED			•	•		•				
E805	RS232, LAN	N/A	LED			•	•		•				
E905	RS232, LAN	N/A	LED			•	•		•				
LCD4020	RS232	RS232	CCFL			N/A	N/A						
LCD4620	RS232	RS232	CCFL			N/A	N/A						
LCD5220	RS232	RS232	CCFL			N/A	N/A						
LCD6520	RS232	RS232	CCFL			N/A	N/A						
M40, M40B, M40-2	RS232	RS232	CCFL			N/A	N/A						
M46, M46B, M46-2	RS232	RS232	CCFL			N/A	N/A						
M401	RS232, LAN	RS232	CCFL					•					
M431	RS232, LAN	LAN	LED			•	•		•				
M461	RS232, LAN	RS232	CCFL					•					
M491	RS232, LAN	LAN	LED			•	•		•				
M521	RS232, LAN	RS232	CCFL					•					
M551	RS232, LAN	LAN	LED			•	•		•				
M651	RS232, LAN	LAN	LED			•	•		•				
MA431	RS232, LAN	LAN	LED	•	•	•	•		•	•	•	•	•

Future firmware updates may add support for some features not indicated above. Please regularly check for the latest firmware at: https://www.sharp-nec-displays.com/dl/en/dp_soft/pd_fm_update

1 - The X-UHD models require at least firmware version 4.6 for SVE. Firmware updates are available at: https://www.sharp-nec-displays.com/dl/en/dp_soft/pd_fm_update/uhd

2 - When the display supports this feature, it is indicated in the Summary window once the display is Verified. See "Summary window" on page 100.

3 - This feature requires minimum firmware version R1.707 on the display model. Firmware updates are available at: https://www.sharp-nec-displays.com/dl/en/dp_soft/pd_fm_update/A5UHD

	Connection	Daisy chain	Backlight	SpectraView Engine (SVE) ²	Uniformity Correction	LAN setting by OSD	LAN Power setting	EXTERNAL CONTROL setting	LAN search	Calibrate without a color sensor	Corner Uniformity ²	Update Factory Color Calibration ²	Update Uniformity Correction ²
MA491	RS232, LAN	LAN	LED	•	•	•	•		•	•	•	•	•
MA551	RS232, LAN	LAN	LED	•	•	•	•		•	•	•	•	•
ME431	RS232, LAN	LAN	LED			•	•		•				
ME501	RS232, LAN	LAN	LED			•	•		•				
ME551	RS232, LAN	LAN	LED			•	•		•				
ME651	RS232, LAN	LAN	LED			•	•		•				
P401	RS232, LAN	RS232	CCFL					•					
P402	RS232, LAN	RS232	CCFL			•		•					
P403	RS232, LAN	LAN	LED			•	•		•				
P404	RS232, LAN	LAN	LED	•	•	•	•		•	•			
P435	RS232, LAN	LAN	LED	•	•	•	•		•	•	•	•	•
P461	RS232, LAN	RS232	CCFL					•					
P462	RS232, LAN	RS232	CCFL			•		•					
P463	RS232, LAN	LAN	LED			•	•		•				
P484	RS232, LAN	LAN	LED	•	•	•	•		•	•			
P495	RS232, LAN	LAN	LED	•	•	•	•		•	•	•	•	•
P521	RS232, LAN	RS232	CCFL					•					
P551	RS232, LAN	RS232	CCFL					•					
P552	RS232, LAN	RS232	CCFL			•		•					
P553	RS232, LAN	LAN	LED			•			•				
P554	RS232, LAN	LAN	LED	•	•	•			•	•			
P555	RS232, LAN	LAN	LED	•	•	•	•		•	•	•	•	•
P654Q	RS232, LAN	LAN	LED	•	•	•	•		•	•	• ³	• ³	• ³
P701	RS232, LAN	RS232	CCFL					•					
P702	RS232, LAN	RS232	CCFL					•					
P703	RS232, LAN	LAN	LED			•			•				
P754Q	RS232, LAN	LAN	LED	•	•	•	•		•	•	• ³	• ³	• ³
P801	RS232, LAN	LAN	LED			•	•		•				
S401	RS232, LAN	RS232	CCFL			•	•	•					
S461	RS232, LAN	RS232	CCFL					•					

Future firmware updates may add support for some features not indicated above. Please regularly check for the latest firmware at: https://www.sharp-nec-displays.com/dl/en/dp_soft/pd_fm_update

1 - The X-UHD models require at least firmware version 4.6 for SVE. Firmware updates are available at: https://www.sharp-nec-displays.com/dl/en/dp_soft/pd_fm_update/uhd

2 - When the display supports this feature, it is indicated in the Summary window once the display is Verified. See "Summary window" on page 100.

3 - This feature requires minimum firmware version R1.707 on the display model. Firmware updates are available at: https://www.sharp-nec-displays.com/dl/en/dp_soft/pd_fm_update/A5UHD

	Connection	Daisy chain	Backlight	SpectraView Engine (SVE) ²	Uniformity Correction	LAN setting by OSD	LAN Power setting	EXTERNAL CONTROL setting	LAN search	Calibrate without a color sensor	Corner Uniformity ²	Update Factory Color Calibration ²	Update Uniformity Correction ²
S521	RS232, LAN	RS232	CCFL					•					
UN462A	RS232, LAN	LAN	LED	•	•	•	•		•	•	•	•	•
UN462VA	RS232, LAN	LAN	LED	•	•	•	•		•	•	•	•	•
UN492S	RS232, LAN	LAN	LED	•	•	•	•		•	•	•	•	•
UN492VS	RS232, LAN	LAN	LED	•	•	•	•		•	•	•	•	•
UN551S	RS232, LAN	LAN	LED			•	•		•				
UN551VS	RS232, LAN	LAN	LED			•	•		•				
UN552	RS232, LAN	LAN	LED	•	•	•	•		•	•	•	•	•
UN552A	RS232, LAN	LAN	LED	•	•	•	•		•	•	•	•	•
UN552S	RS232, LAN	LAN	LED	•	•	•	•		•	•	•	•	•
UN552V	RS232, LAN	LAN	LED	•	•	•	•		•	•	•	•	•
UN552VS	RS232, LAN	LAN	LED	•	•	•	•		•	•	•	•	•
UX552	RS232, LAN	LAN	LED	•	•	•	•		•	•	•	•	•
UX552S	RS232, LAN	LAN	LED	•	•	•	•		•	•	•	•	•
V322	RS232, LAN	RS232	CCFL			•		•					
V323, V323-2	RS232, LAN	RS232	LED			•		•					
V404, V404-T	RS232, LAN	LAN	LED	•		•	•		•	•			
V422	RS232, LAN	RS232	CCFL			•		•					
V423, V423-TM	RS232, LAN	RS232	LED			•		•					
V462, V462-TM	RS232, LAN	RS232	CCFL			•		•					
V463, V463-TM	RS232, LAN	RS232	LED			•		•					
V484, V484-T	RS232, LAN	LAN	LED	•		•	•		•	•			
V551	RS232, LAN	RS232	CCFL			•		•					
V552, V552-2	RS232, LAN	RS232	CCFL			•		•					
V552-TM, V552-TM-2	RS232, LAN	RS232	CCFL			•		•					
V554, V554-T	RS232, LAN	LAN	LED	•		•	•		•	•			
V554Q	RS232, LAN	LAN	LED	•	•	•	•		•	•	• ³	• ³	• ³
V651, V651-TM	RS232, LAN	RS232	CCFL			•		•					
V652, V652-TM	RS232, LAN	RS232	LED			•		•					
V654Q	RS232, LAN	LAN	LED	•	•	•	•		•	•	• ³	• ³	• ³

Future firmware updates may add support for some features not indicated above. Please regularly check for the latest firmware at: https://www.sharp-nec-displays.com/dl/en/dp_soft/pd_fm_update

1 - The X-UHD models require at least firmware version 4.6 for SVE. Firmware updates are available at: https://www.sharp-nec-displays.com/dl/en/dp_soft/pd_fm_update/uhd

2 - When the display supports this feature, it is indicated in the Summary window once the display is Verified. See "Summary window" on page 100.

3 - This feature requires minimum firmware version R1.707 on the display model. Firmware updates are available at: https://www.sharp-nec-displays.com/dl/en/dp_soft/pd_fm_update/A5UHD

	Connection	Daisy chain	Backlight	SpectraView Engine (SVE) ²	Uniformity Correction	LAN setting by OSD	LAN Power setting	EXTERNAL CONTROL setting	LAN search	Calibrate without a color sensor	Corner Uniformity ²	Update Factory Color Calibration ²	Update Uniformity Correction ²
V754Q	RS232, LAN	LAN	LED	●	●	●	●		●	●	● ³	● ³	● ³
V801, V801-TM	RS232, LAN	RS232	LED			●		●					
V864Q	RS232, LAN	LAN	LED	●	●	●	●		●	●	● ³	● ³	● ³
V984Q	RS232, LAN	LAN	LED	●	●	●	●		●	●	● ³	● ³	● ³
X401S	RS232, LAN	RS232	LED			●		●					
X431BT	RS232, LAN	RS232	CCFL					●					
X461HB	RS232, LAN	RS232	CCFL					●					
X461S	RS232, LAN	RS232	LED			●		●					
X461UN	RS232, LAN	RS232	CCFL					●					
X461UNV	RS232, LAN	RS232	CCFL					●					
X462HB	RS232, LAN	RS232	CCFL					●					
X462S	RS232, LAN	RS232	LED			●		●					
X462UN	RS232, LAN	RS232	CCFL					●					
X462UNV	RS232, LAN	RS232	LED			●		●					
X463UN	RS232, LAN	RS232	LED			●		●					
X464UN, X464UN-2	RS232, LAN	LAN	LED			●	●		●				
X464UNS, X464UNS-2	RS232, LAN	LAN	LED			●	●		●				
X464UNV, X464UNV-2	RS232, LAN	LAN	LED			●	●		●				
X474HB	RS232, LAN	LAN	LED			●	●		●				
X551S	RS232, LAN	RS232	LED			●		●					
X551UHD	RS232, LAN	LAN	LED	● ¹	●	●	●		●	● ¹			
X551UN	RS232, LAN	RS232	LED			●		●					
X552S	RS232, LAN	RS232	LED			●		●					
X554HB	RS232, LAN	LAN	LED			●	●		●				
X554UN, X554UN-2	RS232, LAN	LAN	LED			●	●		●				
X554UNS	RS232, LAN	LAN	LED			●	●		●				
X554UNV	RS232, LAN	LAN	LED			●	●		●				
X555UNS	RS232, LAN	LAN	LED			●	●		●				
X555UNV	RS232, LAN	LAN	LED			●	●		●				
X651UHD, X651UHD-2	RS232, LAN	LAN	LED	● ¹	●	●	●		●	● ¹			

Future firmware updates may add support for some features not indicated above. Please regularly check for the latest firmware at: https://www.sharp-nec-displays.com/dl/en/dp_soft/pd_fm_update

1 - The X-UHD models require at least firmware version 4.6 for SVE. Firmware updates are available at: https://www.sharp-nec-displays.com/dl/en/dp_soft/pd_fm_update/uhd

2 - When the display supports this feature, it is indicated in the Summary window once the display is Verified. See "Summary window" on page 100.

3 - This feature requires minimum firmware version R1.707 on the display model. Firmware updates are available at: https://www.sharp-nec-displays.com/dl/en/dp_soft/pd_fm_update/A5UHD

	Connection	Daisy chain	Backlight	SpectraView Engine (SVE)²	Uniformity Correction	LAN setting by OSD	LAN Power setting	EXTERNAL CONTROL setting	LAN search	Calibrate without a color sensor	Corner Uniformity²	Update Factory Color Calibration²	Update Uniformity Correction²
X754HB	RS232, LAN	LAN	LED			•	•		•				
X841UHD, X841UHD-2	RS232, LAN	LAN	LED	• ¹	•	•	•		•	• ¹			
X981UHD, X981UHD-2	RS232, LAN	LAN	LED	• ¹	•	•	•		•	• ¹			

Future firmware updates may add support for some features not indicated above. Please regularly check for the latest firmware at: https://www.sharp-nec-displays.com/dl/en/dp_soft/pd_fm_update



1 - The X-UHD models require at least firmware version 4.6 for SVE. Firmware updates are available at: https://www.sharp-nec-displays.com/dl/en/dp_soft/pd_fm_update/uhd

2 - When the display supports this feature, it is indicated in the Summary window once the display is Verified. See "Summary window" on page 100.

3 - This feature requires minimum firmware version R1.707 on the display model. Firmware updates are available at: https://www.sharp-nec-displays.com/dl/en/dp_soft/pd_fm_update/A5UHD

System Requirements

NEC Display Wall Calibrator has the following system requirements:

	 Windows	 Mac
Operating System	Windows 32 or 64 bit versions: • 8 / 8.1 / 10	macOS 10.13 and higher. Only Intel based Macs are supported.
Display Resolution	1024x768 minimum. 1280x1024 recommended.	
Supported Color Sensors	<ul style="list-style-type: none"> • Datacolor Spyder3 • Datacolor Spyder4 • Datacolor Spyder5 • Datacolor SpyderX • Konica Minolta CA-210 and CA-310 • NEC MDSVSENSOR • NEC MDSVSENSOR3 • NEC SpectraSensor Pro • X-Rite ColorMunki¹ • X-Rite Hubble • X-Rite i1Display Pro • X-Rite i1Display 2 • X-Rite i1Monitor • X-Rite i1Pro • X-Rite i1Pro 2 • X-Rite i1Studio 	<ul style="list-style-type: none"> • Datacolor Spyder3 • Datacolor Spyder4 • Datacolor Spyder5 • Datacolor SpyderX • NEC MDSVSENSOR3 • NEC SpectraSensor Pro • X-Rite ColorMunki¹ • X-Rite i1Display Pro • X-Rite i1Monitor • X-Rite i1Pro • X-Rite i1Pro 2 • X-Rite i1Studio
USB	<p>At least one available USB port for the Color Sensor.</p> <p>An active USB extender cable up to 5M (16 feet) in length can be used, if necessary, with some models of the color sensors. USB extender cables should not be used with the X-Rite i1Monitor, X-Rite i1Pro, X-Rite ColorMunki, or X-Rite i1Studio sensors.</p>	
LAN (for supported display models)	Standard TCP/IP LAN interface (optional if using RS232 or Wireless LAN)	
RS232	<p>One or more RS232 COM Ports (optional if using LAN).</p> <p>Null modem cables to connect devices.</p> <p>A USB to RS232 adapter can be used if necessary.</p>	<p>A USB to RS232 adapter can be used if connecting the Mac to displays via RS232 instead of via LAN.</p> <p>Null modem cables to connect devices.</p>

¹ The X-Rite ColorMunki Display device introduced in mid-2011 is not supported.

What's new in this version

This version of *NEC Display Wall Calibrator* has the following new features and functionality for version 2.1.20:

- Added support for the latest NEC large-screen displays.
- Added Six-Axis color controls for Saturation and Offset in the Display Settings for supported display models.

This version of *NEC Display Wall Calibrator* has the following new features and functionality for version 2.1.10:

- Added support for the Datacolor SpyderX color sensor.

This version of *NEC Display Wall Calibrator* has the following new features and functionality for version 2.1.00:

- Corner Uniformity Correction

On supported display models (see "Corner Uniformity" column in the "Supported Display Monitors" table starting on page 8), this function provides color tint adjustment options for each corner of the screen to improve visual matching with adjacent displays. See Chapter 8 "Visual Trim function" on page 113.

- Update Uniformity Correction

On supported display models (see "Update Uniformity Correction" column in the "Supported Display Monitors" table starting on page 8), this function enhances the factory uniformity measurements, which are used by the SVE to improve screen uniformity, with screen measurements taken using your color sensor. This function can be used, if necessary, to improve the effectiveness of the Uniformity Correction for an individual display. See Chapter 9 "Update Uniformity" on page 118.

- Update Factory Calibration

On supported display models (see "Update Factory Color Calibration" column in the "Supported Display Monitors" table starting on page 8), this function allows the internal color reference used by the SVE to be quickly updated to use measurements taken using your color sensor. This provides several benefits, such as OSD color settings matching the color sensor measurements, faster calibration times, and more accurate color settings. See Chapter 10 "Update Factory Color Calibration" on page 121.

- Calibrate Without Color Sensor

For display models that are SVE equipped, the display's color settings can be set immediately based entirely on the internal color reference settings, and they can "Calibrate" to different Targets without using a color sensor (see "Calibrate without a color sensor" column in the "Supported Display Monitors" table starting on page 8). See Chapter 11 "Calibrating Without a Color Sensor" on page 123.

- Screen Orientation

Allows the physical orientation of each display to be specified in the software. This setting is used to automatically set the rotation of the OSD (On-Screen Display), as well as configure other screen orientation related settings such as Corner Uniformity Correction.

- Real Time Clock

Automatically synchronizes each display's internal RTC (Real Time Clock) to the host computer, which is useful for some display functions such as Schedules.

- Added support for the X-Rite i1Studio color sensor.

Introduction

Overview

The aim of the *NEC Display Wall Calibrator* system is to automatically adjust multiple displays used in a video wall so the color characteristics closely match, thereby creating the visual illusion of a single large display.

In order to accomplish this, the color characteristics of each display are typically measured individually and compared to the other displays in the video wall. The optimal settings for each display can then be calculated so all of the displays will match after calibration.

Since each display will vary in both color and intensity (brightness), due to aging, individual components and tolerances, it is necessary to find the lowest common denominator that all of the displays are capable of collectively achieving. In other words, the video wall can only be as bright as the dimmest individual display.

The color characteristics of each display are measured using a color sensor that is connected via USB to a host PC. The sensor is placed on the screen and a series of test patterns is generated and measured. This process is repeated for all displays.

The host PC does not have to supply video signal to the displays as test patterns are automatically generated, within each display, during calibration. Communications with each display, from the host PC, are performed via either RS232 or LAN (Ethernet) if supported by the display model.

Once all of the displays have been measured, the calibration Target can be calculated. This Target defines the various calibration parameters, such as the white point (color of pure white on the screen), intensity (brightness), gamma, etc.

Each display is then calibrated to this Target by placing the color sensor on the screen while the software adjusts the internal controls of the display. This process is repeated for all displays. Display models equipped with SpectraView Engine can use their internal SVE color reference to set the color settings without the need to use a color sensor to calibrate each Target.

All of the displays will match when the calibration process is complete. The numerical results of the calibration process can be viewed; the configuration settings for each display and the entire project can be saved for future reference and use.

Once the connections to each display has been made and configured, the measurement and calibration process typically takes between 2 to 6 minutes per display depending on the display model and calibration method being used.

The time until the displays need to be re-calibrated will depend on many factors, such as the environment and duration they are used, the age of the displays, the calibration Target settings, and how critical the color matching requirements are. Newer displays will tend to drift more rapidly than displays that have been in use for several days or weeks. Always allow the displays at least 30 minutes to warm up, after powering on, before attempting to measure or calibrate.

Main Features and benefits

NEC Display Wall Calibrator provides the following features and benefits:

- **Automatic calibration** - *NEC Display Wall Calibrator* communicates with the display monitors directly using either RS232 or LAN (Ethernet) connection. See "Connection" in the "Supported Display Monitors" table on page 8 for the type of connection available for the displays. All adjustments to the display settings are performed automatically using this communications link. It is not necessary to manually configure the displays as all of the necessary adjustments are made by the software.
- **Internal Test Patterns** - Displays can be calibrated using internally generated test patterns. This simplifies the operation by allowing calibration to be performed automatically without having to manually select different test patterns during the calibration process, and without the need to connect a PC to the video input of the displays.
- **10 bit internal Look Up Tables (LUTs)** - Each LCD monitor supported by *NEC Display Wall Calibrator* features three internal 10 bit LUTs. These tables allow precise adjustments to be made to the display's Tone Response Curve without reducing the number of displayable colors or introducing color banding artifacts.
- **Gamma Correction** - As well as adjusting the Intensity (luminance) and white point of the displays, the software can also calibrate the grayscale using the internal LUTs of the displays. This means that highly accurate color can be achieved not only at 100% white, but at all steps along the grayscale. A variety of Tone Response Curves can also be applied; from a small simple gamma value to complex custom curves.
- **Flexible Connections** - Displays can be connected to the host calibration PC using RS232, LAN, or in combinations of both. By using a wireless equipped host PC and LAN, displays can be calibrated without making any physical connections to the host PC.
- **Projects** - All display configurations, measurements, and calibration data can be saved as a project file for later reference, re-calibration, restoring settings, etc.
- **Multiple Calibration Sets** - Different display monitor calibration projects can be uploaded to each group of displays, allowing quick and easy switching between different calibration settings without the need to re-calibrate each display.
- **Informative** - A Summary window shows the results of the calibration and the measurement data. This allows for detailed logging and reporting of the calibration procedure. This information can be printed or saved to a PDF file.
- **Flexible** - *NEC Display Wall Calibrator* provides many features and options that make it flexible enough to be used in a large variety of video applications, including "on set" use in TV studios and full DICOM support for medical imaging.
- **Colorimeter function** - The software features a Colorimeter function, which allows direct measurements to be taken by the color sensor and the results displayed in a variety of different formats.
- **Generate ICC Display profile function** - Generates an ICC Display Profile of a display, which can be used together with a color management system and software to produce content with accurate color.
- **Scalable** - Video wall sizes from a 1x1 single display, to a maximum of 100 displays with up to 30 rows or columns are supported.

About SpectraView Engine (SVE)



The SVE is a sophisticated NEC custom color processor engine integrated in supported MultiSync display models. It was first designed to provide highly accurate and stable color on NEC's Professional line of color desktop displays. This technology is now included in most models of NEC large-screen displays. It combines

internal luminance, temperature and time monitoring, together with individual characterization and calibration of each display during production, to provide an unparalleled level of color control, accuracy and stability.

Adjustable color uniformity correction is available on most equipped models, utilizing detailed individual factory screen measurements together with the SVE to produce the best possible matching displays.

The SVE provides the utmost in versatility; from faster and more advanced color calibration, to the ability to accurately emulate colorspace such as AdobeRGB and sRGB, to performing printer output emulations using ICC Profiles and internal 3D Look Up Tables.

Using the SVE

Models that feature the SVE will be identified by the SVE status icon after being verified by the software (see "Displays status icons" on page 54).

Displays that feature the SVE can operate in one of two modes: On or Off

When the SVE is off, the display will behave like other non-SVE enabled displays. The white point can be adjusted using familiar red, green and blue level controls. The grayscale response of the display is measured by the color sensor and a gamma correction LUT is calculated by the software and uploaded to the display. Depending on the display model, when the SVE is off, the screen Uniformity correction using factory measurements is either not available or available with limited capabilities.

When the SVE is on, the display's internal processor will handle many of the color management features and the user color controls allow a unique level of precision to be achieved. The white point is adjusted using a more intuitive CIE xy control and the grayscale response of the display is calculated and managed by the display itself.

For the SVE equipped models that include Uniformity Correction, different levels of compensation can be selected to enable a trade-off between the most uniform brightness and color vs. increased maximum Intensity (brightness). The display intelligently manages these settings as it ages thus allowing a longer period between recalibrations. If necessary, the color tint of the corners for each screen can be adjusted on some models to improve visual matching with adjacent displays. For a list of display models that support these features, see the "Uniformity Correction" and "Corner Uniformity" columns in the "Supported Display Monitors" table starting on page 8.

On supported models, the Update Uniformity Correction function allows factory uniformity measurements, used by the SVE to improve the screen uniformity, to be enhanced by screen measurements taken from your color sensor. This allows for the effectiveness of the Uniformity Correction feature to be improved for an individual display if necessary. See Chapter 9 "Update Uniformity" on page 118. For a list of display models that support this feature, see the "Update Uniformity Correction" column in the "Supported Display Monitors" table starting on page 8.

Also, on supported models, the Update Factory Calibration function allows this internal color reference used by the SVE to be quickly updated to use measurements taken from your color sensor. This can provide several benefits, such as OSD color settings matching measurements taken by the color sensor, faster calibration times, and more accurate color settings. See Chapter 10 "Update Factory Color Calibration" on page 121. For a list of display models that support this feature, see the "Update Factory Color Calibration" column in the "Supported Display Monitors" table starting on page 8.

About SpectraView Engine (SVE), Cont'd.

Using the SVE will give faster calibration times and result in more stable and uniform screen performance. If, for some reason, it is desired not to use the SVE, it can be disabled before calibration in the application Preferences (see "Preferences dialog - Calibration Method panel" on page 62).

The SVE has five Picture Mode memories that can be individually configured and selected. Each Picture Mode can store the complete color settings for a calibration - allowing for easy switching between different calibrations, when needed, using either the OSD, *NEC Display Wall Calibrator* or other software (see "Preferences dialog - SpectraView Engine" on page 66).

Using the SVE will also give access to other advanced functionality, such as the ability to emulate several modes of human color vision deficiency, also known as color blindness, as well as the ability to select the display's output color gamut.

Calibration Overview

Introduction to display monitor calibration

The screen image on color LCD monitors is created by emitting white light from a backlight source, such as cold cathode fluorescent lamps (CCFLs) or Light Emitting Diodes (LEDs), and passing it through individual sub-pixels with red, green and blue filters which form each pixel on the screen. The amount of light that is allowed to pass through each pixel is controlled to form an image on the screen. The color of each pixel is controlled by varying the ratios of light passing through each of the red, green and blue sub-pixels.

The overall brightness, or "Intensity", of the screen is controlled by adjusting the brightness of the fluorescent lamp backlight, however the adjustment range of the backlight is limited. If it is necessary to adjust the Intensity below the level achieved by adjusting the fluorescent lamp backlight alone, further adjustments can be made using the internal LUTs (look up tables) in the display which control the light that passes through each individual pixel.

Likewise, White Point adjustments to the display are made using the internal LUTs to reduce the brightness of one or more colors (red, green, or blue).

Before calibrating, the desired color characteristics of the calibrated video wall must be selected. In *NEC Display Wall Calibrator* these characteristics are called *Calibration Targets*. The software adjusts the monitors to the color characteristics in the selected Target.

When calibrating a video wall, careful consideration should be made as to how the displays will be calibrated so that they match as necessary. The video content shown on the displays, and how it will be divided on individual displays, will determine some of the calibration settings.

For example, when using a video wall consisting of several displays that will be displaying video tiled across all of the displays simultaneously, it is essential that all of the displays match in both White Point and Intensity (brightness).

However, if the displays each show separate video on their screen, then the Intensity matching between the displays may not be as important as having each display be as bright as possible. Having the displays match in White Point only may be sufficient.

The *NEC Display Wall Calibrator* system provides the flexibility for meeting different scenarios such as these.

When calibrating a video wall to match in both White Point (color) and the maximum possible Intensity (brightness), the Target Intensity can only be as high as the dimmest display. Therefore, it is usually necessary to first measure all the displays in their native or uncorrected state to find out the native White Point and Intensity values for each display. From these measurements, the software can calculate the lowest common Intensity value for the chosen White Point.

About Calibration Targets

A Calibration Target consists of up to four specifications that describe the color characteristics of the display:

- **Intensity**
- **White Point**
- **Gamma or Tone Response Curve (TRC)**
- **Contrast Ratio**

Intensity

Intensity specifies the luminance or “brightness” of white when displayed on the screen. The maximum Intensity value of a display will depend on many factors, such as the color temperature of the White Point selected, the type of monitor, individual component tolerances, usage, and age of the display.

Intensity can be measured and specified in units of either Candelas (cd/m^2) or Foot Lamberts (fL) within the application.

The *NEC Display Wall Calibrator* system supports 3 different methods of Intensity adjustment:

- **Maximum Possible Matching** - Calibrates all of the displays to the maximum possible luminance that can achieve a match in both Intensity and White Point. Use this option if it is desired that all of the displays match in both color and brightness. All of the displays will only be as bright as the dimmest display.
- **Maximum Possible Per Display** - Calibrates all of the displays to the maximum possible luminance that each individual display can achieve, while matching up the white points on each display. Use this option if it is desired that all of the displays match in color, but it is not important if they match each other in luminance.
- **Specific Level** - Calibrates all of the displays to a specified target value of luminance, while matching the white points on all of the displays. If a display cannot achieve the specified value, it will be calibrated to the closest possible Intensity and a warning icon will be displayed after the calibration process is completed. Use this option if the particular application requires a specific luminance, but keep in mind that each display must actually be capable of achieving that value.

The difference between Maximum Possible Matching and Maximum Possible Per Display Intensity adjustment types is illustrated below:

Maximum Possible Matching Intensity Adjustment

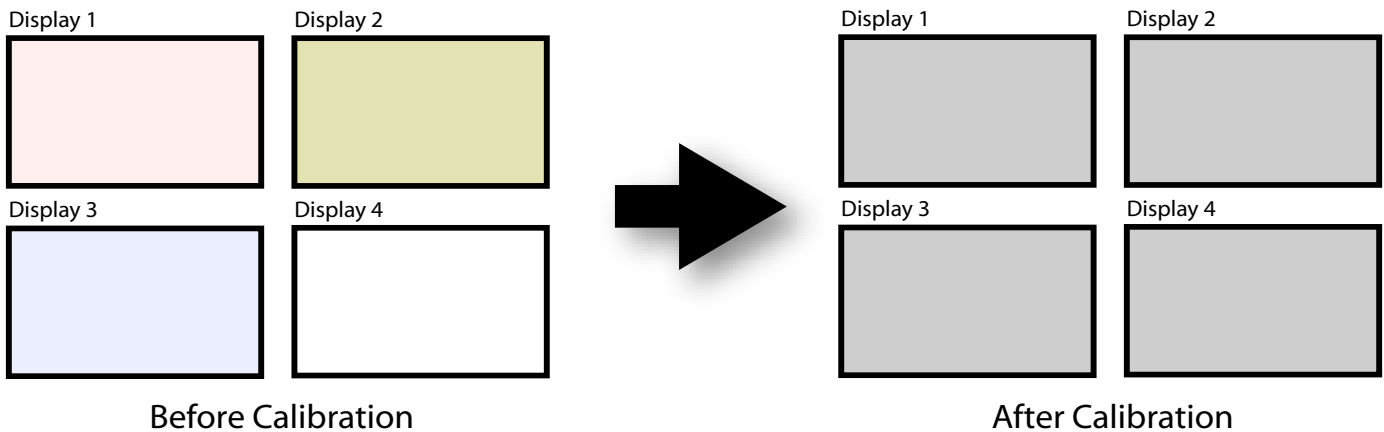

Maximum Possible Per Display Intensity Adjustment

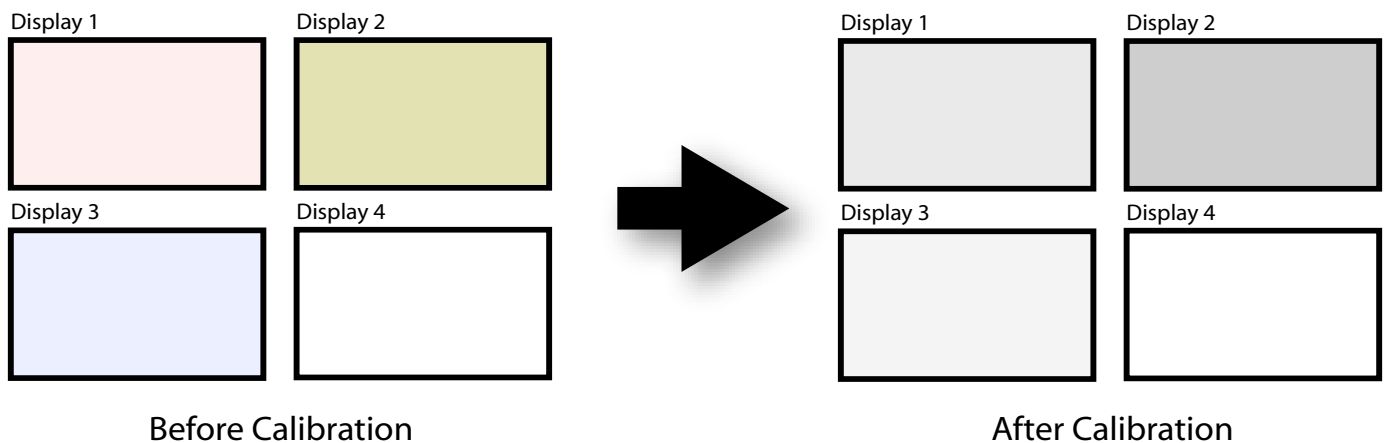

The choice of Intensity adjustment method will depend on the particular application and viewing environment.

If the displays are being used in a bright environment, then the Intensity would generally need to be the maximum possible. So either **Maximum Possible Matching** or **Maximum Possible Per Display** would be used.

White Point

The White Point specifies the color of pure “white” on a display. Since there is no unique perceptual or physical definition of what “white” is, it must be defined in terms of a standard or device-independent color space to be measured and reproduced.

There are several methods of specifying a white point, including using a blackbody radiator color temperature or as a point in a device-independent color space. *NEC Display Wall Calibrator* allows the white point to be specified either as a black body radiator color temperature in Kelvin, as a CIE standard illuminant, or as CIE xy chromaticity coordinates.

A White Point expressed as a blackbody radiator color temperature in Kelvin represents the light given off by an object, known as a blackbody, as it is heated to a given temperature. Low color temperatures, such as 2500K, are reddish, while higher color temperatures, such as 9300K, are bluish. A color temperature of 6500K is considered to be “neutral” white.

A CIE Standard Illuminant is a defined white color based on a known light source. In *NEC Display Wall Calibrator* the D or Daylight Illuminant series can be used to specify a white point. Daylight Illuminants are named according to their corresponding correlated color temperature. For example, D50 is very close in color to a 5000K blackbody radiator.

Since adjusting the White Point away from the native value of the display involves reducing the level of at least one color (red, green, or blue), the brightest possible display will be when the least amount of correction is made. Choosing a White Point that is very different from the native White Point will mean that a large correction must be applied, and the maximum brightness will be impacted.

If the application the video wall is being used for does not need a specific White Point, and the brightest possible display is required, a White Point that will achieve the highest possible overall Intensity after calibrating can be automatically calculated. This calculation factors in the native Intensity and White Points of each display in order to determine the resulting White Point. This function is available in the White Point group in the *Edit Calibration Target* dialog.

Gamma and Tone Response Curves (TRC)

The Gamma or Tone Response Curve of a display is the relationship between the video input signal level and the light output (“brightness”) displayed on the monitor. The display monitor is a nonlinear display device. In simple terms, this means that doubling the level of the video input signal to the display does not double the light output. For CRT based displays, the light output follows a mathematical power function of the input video signal. This power function has an exponent called gamma, which is commonly used to describe the relationship between the video input signal and light output of the screen.

A gamma value of 1 would result in a perfectly linear display (doubling the signal level doubles the light output) and the Tone Response Curves would be straight lines. The particular Tone Response Curves of a display will change with the display color settings and may vary from one display to the next. If accurate color matching is to be performed, the display’s Tone Response Curves must be accurately measured and compensated for. *NEC Display Wall Calibrator* uses the color sensor to automatically measure the Tone Response Curves of the display.

Normally, a standard Gamma value is required when working with images. For example, the sRGB standard color space target specifies a display Gamma value of 2.2. Since the Gamma value of the display may be different than the required Gamma value, a correction needs to be applied so the apparent display Gamma matches that of the required Target. In *NEC Display Wall Calibrator*, this correction is applied to the LUTs (Look Up Tables) inside the monitor. The software also uses the monitor’s LUTs for Targets that have Tone Response Curves which do not follow a normal Gamma curve. An example is DICOM, which uses a curve that changes shape based on how bright the display is.

Calibrating the gamma or Tone Response Curve of the display during calibration will automatically correct for any color deviations in shades of gray between black and white. This provides the best possible grayscale color tracking.

Contrast Ratio

The Contrast Ratio of the display is the ratio of the measured Intensity to the measured Black Level. The Black Level is the luminance or “brightness” of black when displayed on the screen. For LCD monitors the minimum or *native* Black Level is typically fixed in ratio to the Intensity value due to the display technology.

NEC Display Wall Calibrator allows the Contrast Ratio to be selected for applications that require a specific contrast ratio. However, the calibrated contrast ratio cannot be higher than the native contrast ratio, since the minimum Black Level that the display can achieve is limited by the display technology.

The Contrast Ratio is adjusted (reduced) by increasing the black level as necessary.

For most applications, the highest possible Contrast Ratio is suitable and can be achieved by selecting **Monitor Default** as the **Contrast Ratio**.

Specific Contrast Ratios in the range 50:1 to 500:1 can be selected.

 **Note:** If the selected contrast ratio is higher than what the display is actually capable of achieving, the display will calibrate to the highest possible contrast ratio. For example, if 500:1 is selected, but the display is only capable of 320:1 with the current Target settings, the resulting calibration will have a contrast ratio of 320:1.

Calibration Steps

The display calibration process for a video wall, when matching both the Intensity and White Point, is outlined in the following steps.

1. **Verifying Displays** - This step verifies the software can communicate with each display correctly.
2. **Initializing Displays** - This step resets each display to the default color settings so the “native” performance of each display can be measured before the calibration. Settings such as the Brightness, Color mode, Contrast, etc., will be reset.
3. **Measuring Displays** - During this step, all displays are measured to determine the default “native” color characteristics of each display. This step involves placing the color sensor on the screen while various test patterns are displayed and measured. This step is repeated for all displays in the video wall.

Target Calculation - Once all of the displays have been measured, the software will automatically calculate the maximum possible Intensity that will give a color match with all of the displays. This is done by determining the dimmest display in the video wall at the chosen White Point.

4. **Calibrating Displays** - Once the Target has been calculated, all of the displays can be calibrated. This step involves placing the color sensor on the screen while various test patterns are displayed and the display is adjusted. This step is repeated for all displays in the video wall.
5. **Optional Evaluate Calibration** and perform **Visual Trim**  (**fine tune by eye**) - If necessary, the white point and brightness of the displays can be visually fine tuned using the software.

Depending on the display model and calibration method used, it may also be possible to adjust the screen uniformity correction level and the screen corner color tint to improve the screen evenness and matching with adjacent displays.

 **Note:** When calibrating to a Target that uses either **Maximum Possible Per Display** or **Specific Level** option for the Intensity, steps 3 and 4 are optional because it is not necessary to measure and calculate the matching Target value.

However, if **Specific Level** is used, performing steps 3 and 4 will allow the software to verify that each display is capable of achieving the specified Intensity value at the selected White Point. If a display cannot achieve this, then a yellow warning icon (⚠) is shown in both the Summary window and in the main display window for that particular display.

 **Info:** For display models that feature the SVE technology, it is possible to calibrate the displays without using a color sensor, which reduces the number of calibration steps to Verify, Calibrate, and (optionally) Visual Trim. See Chapter 11 "Calibrating Without a Color Sensor" on page 123.

Calibration Projects

The *NEC Display Wall Calibrator* application uses Project files to store the following information and settings:

- Layouts including all of the connection settings and video wall size information.
- Measurements for each display, including the time each measurement was taken.
- Calibration results for each display, including the final color characteristics of each display and when it was calibrated.
- Calibrated Monitor Settings for each display so that settings can be restored to one or all displays if necessary.

All of the display measurements and settings are unique to each display and are identified within the software by the model and serial number of the display.

Project files can be saved at any point. By saving Projects using different file names, different configurations for the same video wall can be stored and later restored to the displays if necessary.

Project files can also be used to keep track of when a video wall was last calibrated.

Analog Video Inputs - Important Notice

The display calibration process adjusts the digital portion of the video processing within the display. For analog video signals such as VGA, RGB/HV, and Option-Analog, the signal is digitized within the display using an Analog-to-Digital converter. Due to variances in analog video signal levels and offsets from the video source device, it may be necessary to also adjust the settings for the video Analog-to-Digital conversion.

If the screens on the video wall do not match well in color after calibration, use the **Test Pattern** tool with the **Calibrated White** setting to evaluate the displays using their internally generated test patterns. If the Test Patterns match well, then it indicates that the analog video signal levels need to be adjusted. Use the **Display Settings** dialog - **Video** panel to perform an automatic adjustment of the video levels.

If the analog automatic adjustment procedure still does not provide a good enough match between displays, a more advanced manual method of adjusting the analog video signal levels can be used.

See "Figure 3: Overall calibration determination for displays and analog video inputs" on page 135 for a detailed guide on the process of determining when to calibrate and perform the analog setup.

 **Note:** This adjustment process requires specific patterns to be displayed on the video signal in order for the display to automatically adjust the video signal levels correctly. Failure to display the correct signal may result in the video levels being incorrectly set and the displays may not match in color when using an analog video source.

Planning and Configuring a Wall Layout

Planning

Careful planning prior to installing, wiring, and configuring a video wall will help streamline the process. This chapter provides some insight into different configurations and the amount of time required to successfully calibrate a video wall.

In order for the software to uniquely identify and communicate with each display, the following configuration settings must be made:

- The number of rows and columns of displays in the video wall.
- The communications interface type for each display (RS232 or LAN).
- How the displays are connected to the host PC, and to each other.
- The Monitor ID of each display.
- The order in which displays are assigned IP addresses and Monitor IDs.

i Info: NEC Display Wall Calibrator includes a **Layout Wizard** which greatly assists in planning the configuration and connections of a video wall. This feature can be used for planning purposes before any hardware is installed in order to determine the optimal configuration for smooth deployment, configuration, and calibration. See "Configuring a Layout with the Layout Wizard" on page 42 for more information.

Physical Considerations

For large video walls, where it is necessary to use a ladder or platform to access the screen of each display, careful consideration should be made of the display layout in order to minimize physical movement and maximize the efficiency and speed of the calibration process.

For example, if using a ladder, it may be easier to calibrate a vertical column of displays and then move the ladder across to the next column. Similarly if using a horizontal platform, it may be easier to calibrate a horizontal row of displays and then move the platform up or down to the next row.

For very large video walls, for example larger than a 5x5, it may be more efficient to split the calibration into two separate projects and divide the wall into two. However, keep in mind that depending on the calibration Target type being used, it may be necessary to measure all of the displays in the video wall in order to determine the dimmest display.

For video walls that use LAN based daisy-chaining and use the Auto ID function, the Monitor IDs are assigned based on the physical wiring connection order from the first display. So the connection order of the LAN cables between displays is an important consideration.

 Note: The calibration order for existing video wall configurations can be changed at any time using the "Calibration Order" on page 50.

For irregular shaped video walls (non-rectangular), displays that are not in the video wall setup can be excluded from calibration by disabling them. See Configuration in "Frequently Asked Questions" on page 108.

About Monitor IDs



- Each display has a Monitor ID number that is used to individually identify and address it when used in multi-display configurations.
- Each display in a daisy-chain must have a unique Monitor ID.
- The Monitor ID is configured via the OSD or embedded web page (LAN only).
- Models that support LAN daisy-chains can have the Monitor ID set automatically using the Auto ID function. See "Using the Auto ID function with a LAN daisy-chain" on page 30 and the display User's Manual for more information.
- The Monitor ID configured in the software must match the Monitor ID on each display.
- Monitor IDs also allow displays to be individually controlled from a single IR remote control. See the display User's Manual for more information on using the IR Remote with multiple displays.

Configuring Connections

Displays can be connected to the host PC in a variety of ways using RS232 or LAN, depending on the model.

Displays can also be daisy-chained together using RS232 or LAN cables, depending on the model. Daisy-chaining displays can simplify cable wiring, and allows more than one display to be controlled from one access connection, as well as minimizing the lengths and number of cable runs.

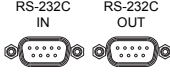
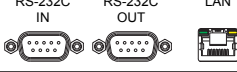
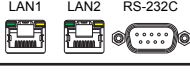
The following table shows the types of daisy-chains available depending on the connection configuration of the display model being used.



Display connection configuration	Connection description	Daisy-chain type	Input connection to first display in daisy-chain
	RS-232C IN and OUT	RS232	RS232
	RS-232C IN, OUT, and LAN	RS232	LAN or RS232 (selectable)
	RS-232C IN, LAN 1 and LAN2	LAN	LAN or RS232
	RS-232C IN and LAN	Not available	LAN or RS232

There are several ways to determine the correct display connection configuration for each model:

- Use the **Layout Wizard** and select the display model.
- See "Connection" in the "Supported Display Monitors" table on page 8.
- Look at the physical connections on the display.
- Refer to the display's User's Manual.

The following sections describe each of the 3 basic connection types for connecting multiple displays.

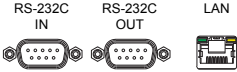
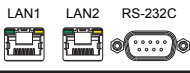
Direct LAN

Supported display connection configurations		
	RS-232C IN, OUT, and LAN	
	RS-232C IN, LAN 1 and LAN2	
	RS-232C IN and LAN	

Models that have an RJ45 LAN connection can be individually connected directly to a LAN via a hub or switch instead of daisy-chaining displays together. This may require more wiring since each display is individually connected directly to a central LAN hub or switch. The advantages of using this method is that communications to other displays will still function even if:

- A display is removed from the video wall without bridging the daisy-chain.
- A display loses AC power or is turned off via the display's main power switch.
- A display fails.
- There is a fault in cabling to an individual display.

- A display enters standby power mode and the LAN POWER setting is set to OFF. See "Daisy chain" in the "Supported Display Monitors" table on page 8 for models that support LAN daisy chain.

See "Example: Direct Multi IP LAN" on page 35.

Important points to note:

- Each display must have a unique IP address.
- Since each display is addressed by the combination of IP address and Monitor ID, each display can have the same or unique Monitor IDs.

RS232 Daisy-chain

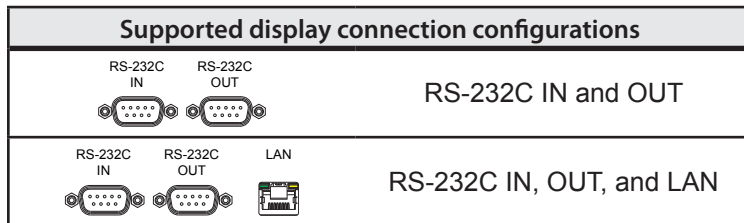

Models that have two RS232 connections (not including any RS232 connections on OPS devices), support RS232 daisy-chaining. The connection labeled IN is the input to the display from the host PC. The other connection labeled OUT is the output to connect to the IN on the next display in the daisy chain.

See "Example: Single IP LAN with daisy-chained RS232" on page 33 and "Example: Daisy-chained RS232 with one COM port" on page 31.

Important points to note:

- When using RS232 to connect displays using a daisy-chain, each display on the chain must have a unique Monitor ID (set via the display's OSD).
- Displays must be connected using an RS232 serial NULL modem cable (also known as a "crossover" cable).
- The first display in the daisy-chain can be connected to the host PC either via RS232, or by LAN if the model has an RJ45 LAN connection (not including any RJ45 LAN connections on OPS devices). When connected via LAN, the first display can forward commands received over LAN to other displays in the RS232 daisy-chain.
- The RS232 connection from the host PC must connect to the RS232 IN on the first display.
- Communications to the display via both LAN and RS232 are not supported at the same time. The type of communications link to use must be selected by OSD setting EXTERNAL CONTROL to either RS-232C or LAN. See "Connection" in the "Supported Display Monitors" table on page 8 for the type of connection available for each model.

LAN Daisy-chain

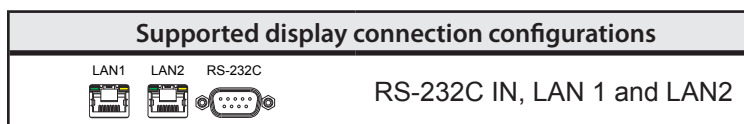

Models that have two RJ45 LAN connections (not including any RJ45 LAN connections on OPS devices) support LAN daisy-chaining. The RJ45 LAN connection labeled LAN1 should be used as an input to the display from the network or

host PC. The other LAN connection labeled LAN2 is the output to connect to the LAN1 on the next display in the daisy chain.

The display functions as a two port LAN hub for LAN traffic.

Important: The LAN hub function only works when AC power is applied to the display and the LAN interface is powered on. By default the LAN POWER setting is set to turn off when the display enters a standby power mode. This will prevent communications with other devices along the LAN daisy-chain. To prevent this, change the LAN POWER setting to ON - either via the OSD, or via the . This setting will also be automatically set to ON when the Initialize action is used. See "LAN Power setting" in the "Supported Display Monitors" table on page 8 for models that support this feature.

The first display in a LAN daisy-chain communicates with the host PC using either an RS232 direct connection or via LAN1 over the network. Selection between the LAN1 and RS232 ports is done automatically by the display.

Displays in a LAN daisy-chain that are connected to a LAN network can be addressed by the software in two ways:

➤ **Direct:**

Each display in a LAN daisy-chain can also be communicated with directly by addressing the display by its IP address and Monitor ID.

This method is faster as NEC Display Wall Calibrator can perform many types of operations in parallel to all displays using the multi-threading functionality.

See "Example: Multi IP LAN using LAN daisy-chain" on page 37.

➤ **Via Translation:**

The first display in a LAN daisy-chain can act as a host for commands it receives for any of the other displays further along the daisy-chain. It will translate and forward, to the relevant display, any commands received via the LAN2 connection sent to its IP address but with Monitor IDs for other displays in the daisy-chain.

In order to do this, the Auto ID function must be successfully performed on the first display. The Auto ID function is used to identify all displays along the LAN daisy-chain and assign them sequential Monitor IDs. The first display in the LAN daisy-chain stores a table of the IP addresses and assigned Monitor IDs for all of the other displays in the daisy-chain.

This method is slower as NEC Display Wall Calibrator does not perform operations in parallel.

 **Note:**

- The translation process is always used when connecting to the RS232 port on the first display. See "Example: RS232 using LAN daisy-chain" on page 40.
 - This translation and forwarding process makes communications slightly slower.
 - Using translation with a LAN connection to the first display will prevent the software from utilizing the multi-threading functionality to communicate with multiple displays in parallel. Multi-threading greatly speeds up many operations, therefore, it is highly recommended to use "Direct".
-

See the following for more information on using the Auto ID function.

Using the Auto ID function with a LAN daisy-chain

- The LAN2 RJ45 (output) of a display must connect to the LAN1 RJ45 (input) on the next display in a daisy-chain.
- Each display must have a unique IP address assigned.
- Network hub devices must not be used to create multiple branches of displays along the LAN daisy-chain. All displays must be connected sequentially.
- The LAN2 RJ45 of the last display in the daisy-chain must not be connected back to the network (do not form a network loop).
- Monitor IDs are automatically assigned sequentially starting at Monitor ID 1.
- Monitor IDs are assigned based on the physical LAN cable connection order - not the IP address assignment order.
- All displays must be powered on when performing the Auto ID function.
- The Auto ID function should only be performed from the first display in the daisy-chain. Do not perform Auto ID from displays farther along the daisy-chain.

Using DHCP (Dynamic Host Configuration Protocol)

- Using DHCP with a video wall connected via LAN is not recommended, since the IP address assigned to each display may change if the entire system is restarted.
- The software always uses static IP addresses together with a Monitor ID to individually address each display. If the IP address changes the wrong display location may be unintentionally accessed.

Example: Daisy-chained RS232 with one COM port

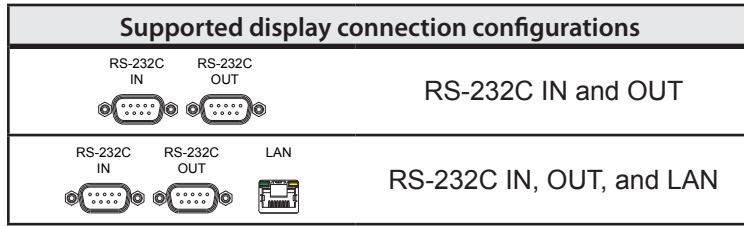

In this example, the host PC has one RS232 COM port and all displays are daisy-chained together via RS232. Each display must have a unique MONITOR ID since they are all on the same daisy-chain. The RS232 OUT on the first display is connected to the RS232 IN on the next, etc.

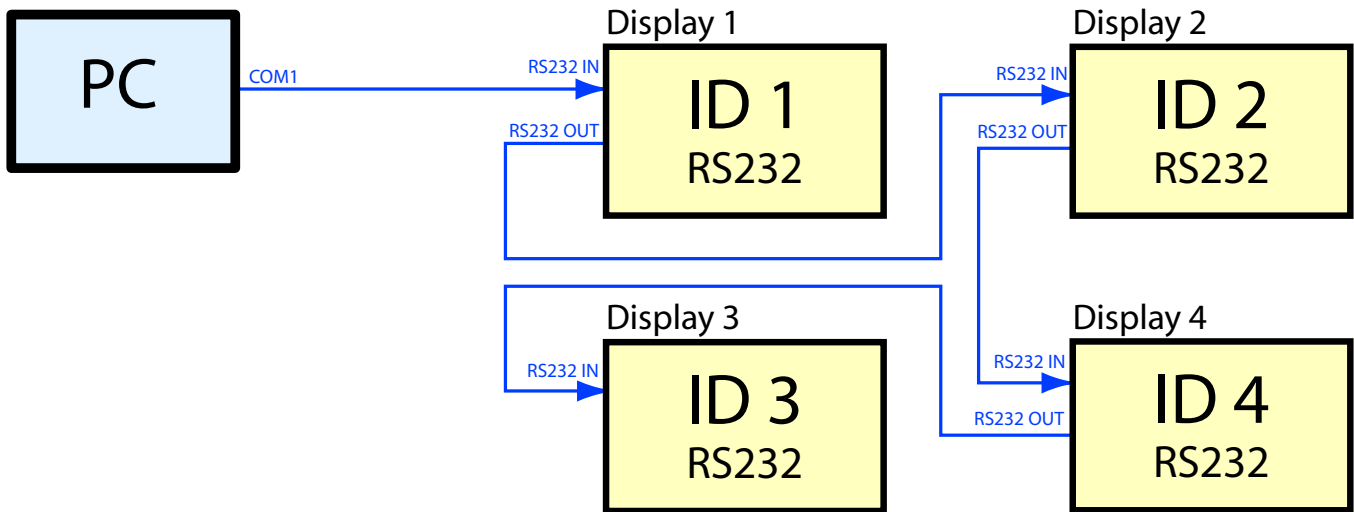

Info: For RS232 daisy-chains, the cable connections between displays does not need to follow the same ordering as the ID assignments. In this example the daisy-chain is connected in order 1 - 2 - 4 - 3.

The following image shows how this layout looks in the Summary window when configured. Notice that all displays are configured to use the same COM port, even though only the first display is actually connected to the host PC.

Summary					
Connection Summary:					
	Port	Monitor ID	Model	Serial Number	Firmware Version
1	COM1	1			
2	COM1	2			
3	COM1	3			
4	COM1	4			

Example: Daisy-chained RS232 with multiple COM ports

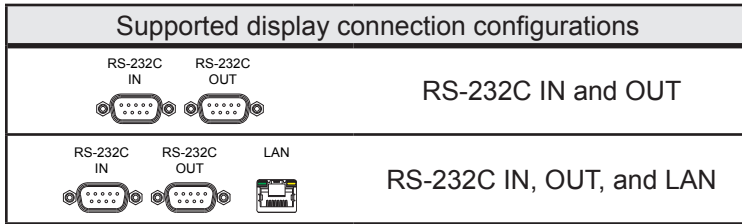

In this example, the host PC has two RS232 COM ports and there are two separate daisy-chains. Each display on a daisy-chain must have a unique MONITOR ID.

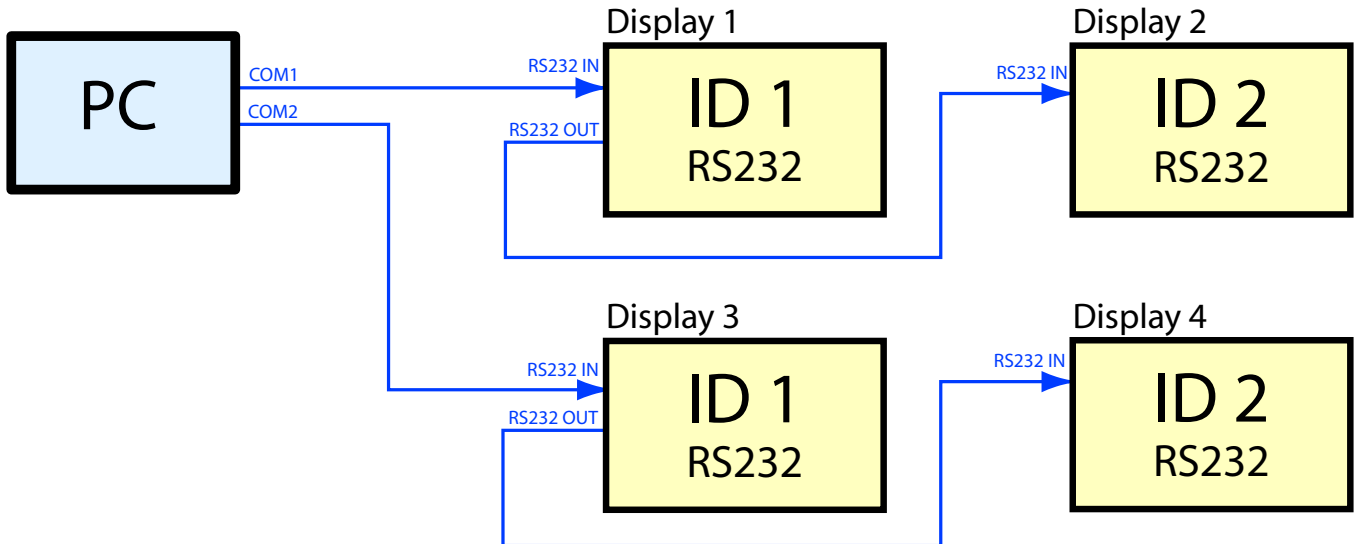

The following image shows how this layout looks in the Summary window when configured. Notice that displays connected on COM1 can have the same IDs as those on COM2 because they are on separate daisy-chains.

Summary					
Connection Summary:					
	Port	Monitor ID	Model	Serial Number	Firmware Version
1	COM1	1			
2	COM1	2			
3	COM2	1			
4	COM2	2			

Important: This type of connection that uses two or more separate COM ports cannot be fully configured using the Layout Wizard. Use the Layout Wizard to configure the video wall size and first COM port, then manually edit the connections for each display using the Connection Panel to set the other COM ports to use and Monitor IDs.

Example: Single IP LAN with daisy-chained RS232

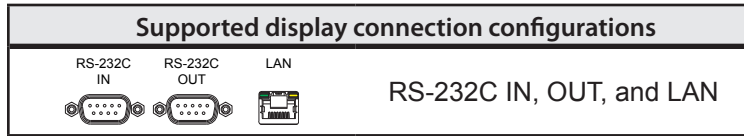

In this example, the host PC is connected to the first display via LAN. Subsequent displays are connected together using RS232 daisy-chaining. Each display on a daisy-chain must have a unique MONITOR ID.

Info: The first display is configured to use LAN as the EXTERNAL CONTROL on the OSD. The other displays are configured to use RS232 as the EXTERNAL CONTROL on the OSD. The RS232 OUT on the first display is connected to the RS232 IN on the next display.

Since communications to all of the displays is routed through the first display, the software uses only the IP address of the first display. The first display then translates commands received via LAN to the RS232 OUT to be received by the other displays in the video wall.

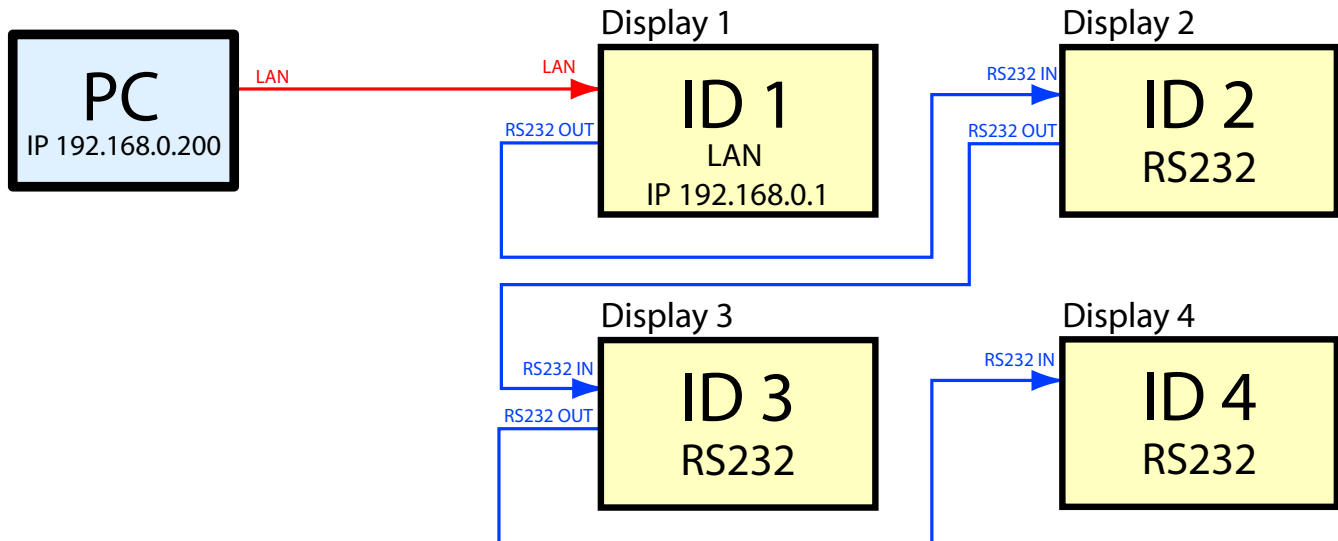



The following image shows how this layout looks in the Summary window when configured. Notice that all of the displays are configured in the software to use the LAN IP address 192.168.0.1, even though displays 2, 3, and 4 are connected together via RS232.

Summary

Connection Summary:

	Port	Monitor ID	Model	Serial Number	Firmware Version
1	192.168.0.1	1			
2	192.168.0.1	2			
3	192.168.0.1	3			
4	192.168.0.1	4			

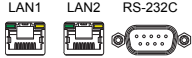
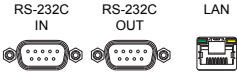
Example: Direct Multi IP LAN

Supported display connection configurations		
	RS-232C IN, LAN 1 and LAN2	
	RS-232C IN, OUT, and LAN	
	RS-232C IN and LAN	

In this example, the host PC and each display are individually connected to the LAN via a hub. Each display has a unique IP address.

Important: Models with only one LAN connection must be configured to use LAN as the EXTERNAL CONTROL on the OSD. Models with two LAN connections do not have this setting.

The software is configured with the IP address and MONITOR ID of each display.

The Monitor ID of each display does not need to be unique since the displays are not daisy-chained. However, the ID set on the OSD must match that set in the software.

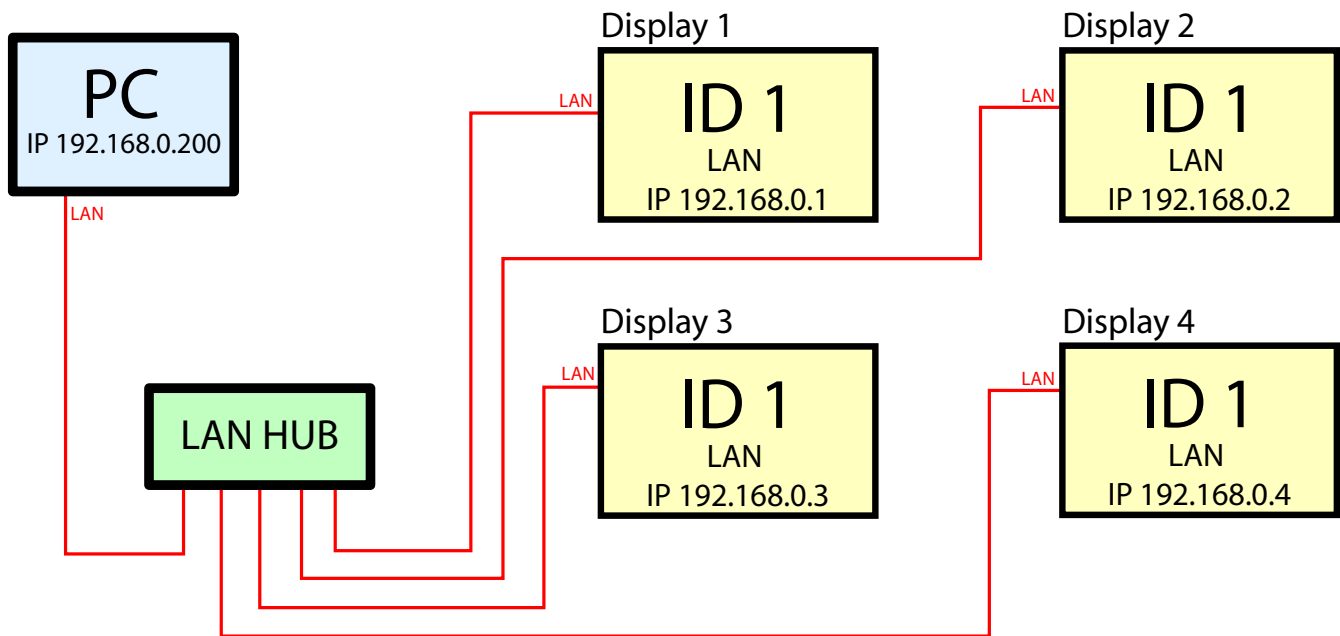



The following image shows how this layout looks in the Summary window when configured.

Summary

Connection Summary:

	Port	Monitor ID	Model	Serial Number	Firmware Version
1	192.168.0.1	1			
2	192.168.0.2	1			
3	192.168.0.3	1			
4	192.168.0.4	1			

Example: Multi IP LAN using LAN daisy-chain

Supported display connection configurations		
LAN1	LAN2	RS-232C
		
RS-232C IN, LAN 1 and LAN2		

In this example, displays are daisy-chained together using LAN connections. The host PC is connected to the first display via the LAN1 RJ45 connection, and the LAN2 (output) is connected to the LAN1 (input) on the next display in the daisy-chain.

Each display has a unique IP address manually assigned.

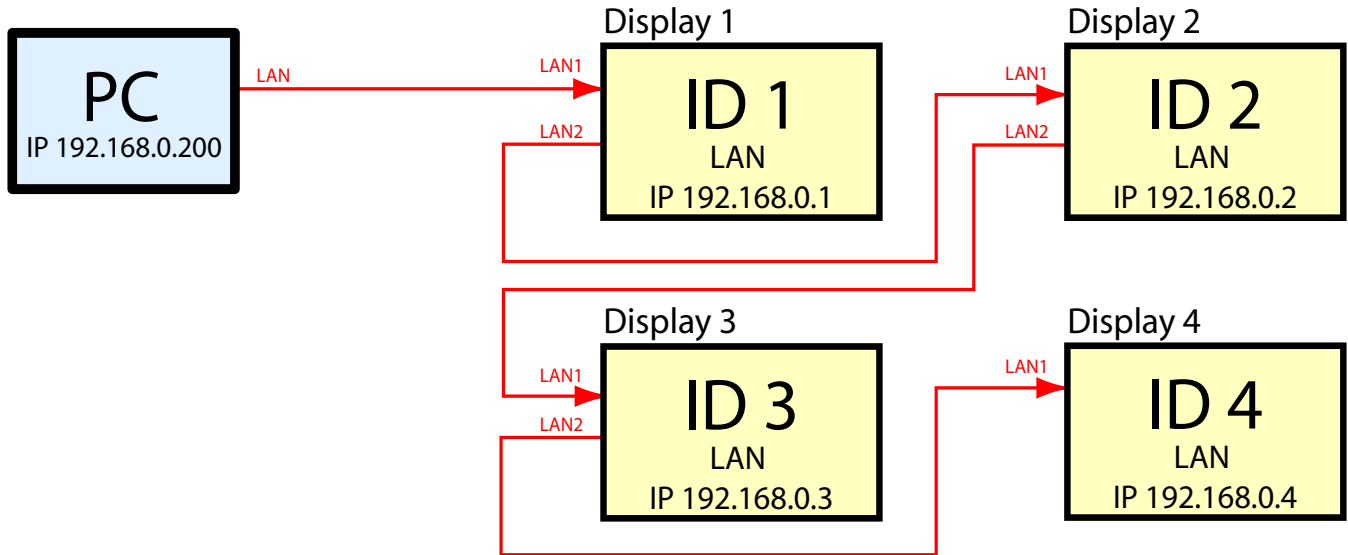

The displays act as 2-port LAN hubs and pass LAN communications through.

The Auto ID operation must be performed manually on the first display once all of the displays are connected and powered up. See "Using the Auto ID function with a LAN daisy-chain" on page 30 for more information on performing this operation. This will automatically detect the displays in the LAN daisy-chain and assign sequential Monitor IDs based on the physical cable connection order of the displays.

Important:

AC power must be applied to the displays in order for each LAN hub to function.

The LAN POWER setting on each display must be set to ON to allow the display to function as a LAN hub, even when the display is in a power saving mode. If this setting is set to OFF, the LAN hub will not function when the display is in a power saving mode and communications to other devices in the daisy-chain will be lost. To prevent this, change the LAN POWER setting to ON - either via the OSD, or via the Power Panel (see "Display Settings dialog - Power panel" on page 82). See "LAN Power setting" in the "Supported Display Monitors" table on page 8 for models that support this feature.

This layout can be configured in the software in two different ways.

➤ **Direct (recommended)**

Since each display acts like a LAN hub, each can be addressed directly by using its IP address and Monitor ID. The software should be configured with the IP address and Monitor ID of each individual display. Commands for a particular display are sent directly to that display over the LAN connection.

This method is faster as NEC Display Wall Calibrator can perform many types of operations in parallel to all displays using the multi-threading functionality.

The following image shows how this layout looks in the Summary window when configured. Notice that all displays are configured to their individual IP address and Monitor IDs.

Summary					
Connection Summary:					
	Port	Monitor ID	Model	Serial Number	Firmware Version
1	192.168.0.1	1			
2	192.168.0.2	2			
3	192.168.0.3	3			
4	192.168.0.4	4			

➤ **Via Translation (slower)**

Once the Auto ID operation has been performed on Display 1, it remembers the IP addresses of all the displays further along the LAN daisy-chain. Also all displays are automatically assigned sequential Monitor IDs. Display 1 can act as a host for commands it receives for any of the other displays, and will translate and forward these commands over the LAN connection to the relevant display further down the daisy-chain. This translation and forwarding process makes communications slightly slower. Since the first display in the daisy chain stores the LAN configuration of all of the other displays in the daisy-chain, if it is replaced the Auto ID operation must be repeated on the replacement display.

This method is slower as NEC Display Wall Calibrator will not perform operations in parallel.

The following image shows how this layout looks in the Summary window when configured. Notice that all displays are configured to use the IP address of the first display, but have distinct Monitor IDs.

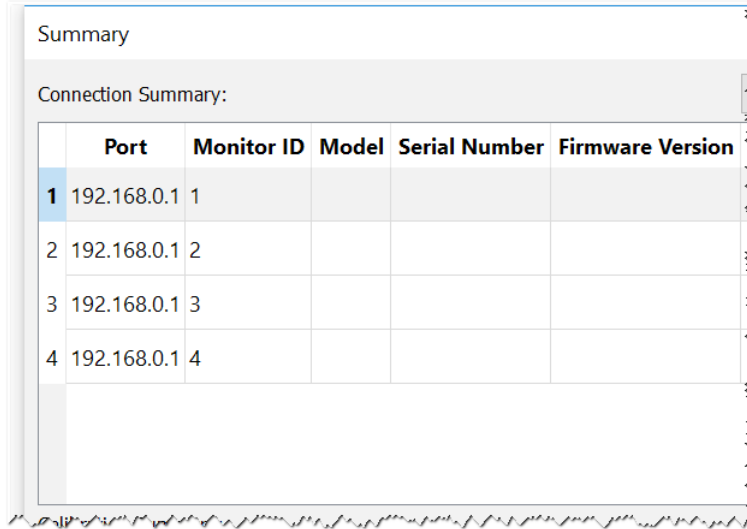



Summary

Connection Summary:

	Port	Monitor ID	Model	Serial Number	Firmware Version
1	192.168.0.1	1			
2	192.168.0.1	2			
3	192.168.0.1	3			
4	192.168.0.1	4			

Important: Since the Monitor ID numbers are assigned sequentially based on the physical connection order of the displays when the Auto ID operation is performed, the layout and ID assignments in the software must match accordingly.

Example: RS232 using LAN daisy-chain

Supported display connection configurations		
LAN1	LAN2	RS-232C
		
RS-232C IN, LAN 1 and LAN2		

In this example, the host PC is connected to the first display via RS232. The displays are daisy-chained together using LAN connections. The LAN2 (output) is connected to the LAN1 (input) on the next display in the daisy-chain.

Each display has a unique IP address assigned.

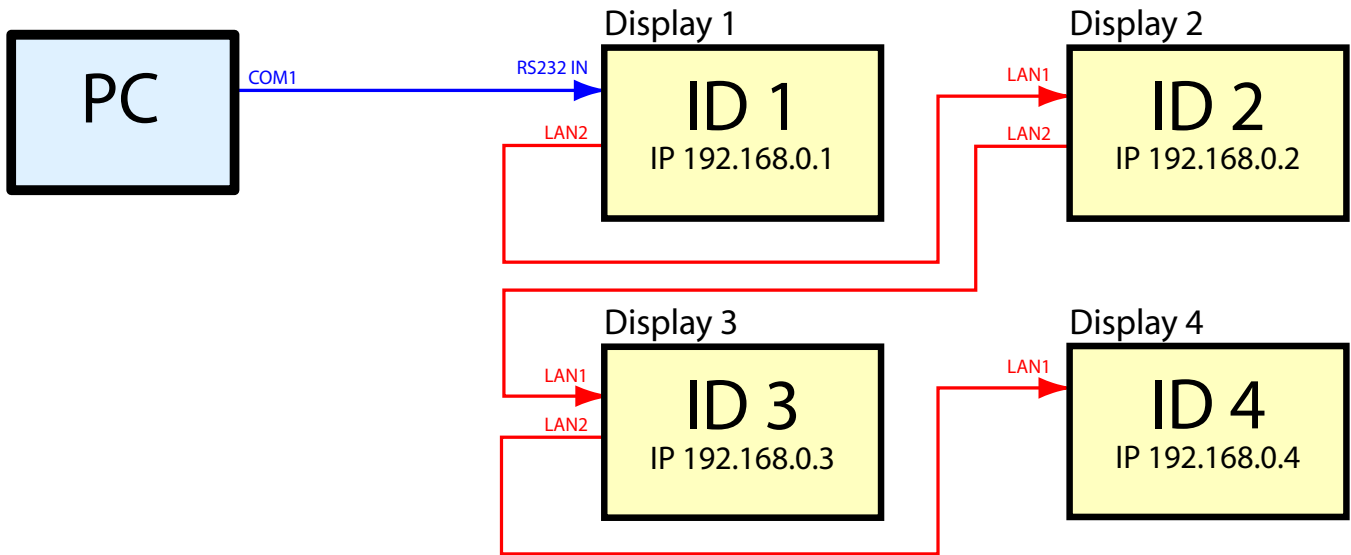

The first display will translate and forward RS232 communications from the host PC over the LAN connection to the other displays.

The Auto ID operation must be performed manually on the first display once all of the displays are connected and powered up. See "Using the Auto ID function with a LAN daisy-chain" on page 30 for more information on performing this operation. This will automatically detect the displays in the LAN daisy-chain and assign sequential Monitor IDs based on the physical cable connection order of the displays.

Note:

If the displays are going to be connected to a network in order to provide remote control or monitoring (by connecting LAN1 on Display 1 to the LAN) then each display should have a unique IP address assigned manually.

However, if the displays are not going to be connected to a network and only the RS232 connection on the first display will be used, then it is not necessary to manually assign them IP addresses. The displays will automatically assign themselves IP addresses if no DNS is detected and the IP SETTING is set the AUTO.

Since communications to Displays 2, 3 and 4 is routed through and translated by Display 1, the software is configured to so that Displays 2, 3, and 4 use the same RS232 COM port as Display 1, even though they are using a daisy-chain LAN connection to Display 1. When using this connection method some operations will be slower as it is not possible to perform operations in parallel.

Important: The Monitor ID numbers are assigned sequentially based on the physical connection order of the displays when the Auto ID operation is performed. The layout and ID assignments in the software must match accordingly.

The following image shows how this layout looks in the Summary window when configured. Notice that all displays are configured to use the same COM port, even though only the first display is actually connected to the host PC.

Summary

Connection Summary:

Port	Monitor ID	Model	Serial Number	Firmware Version
1	COM1 1			
2	COM1 2			
3	COM1 3			
4	COM1 4			

Connecting to displays wirelessly

When calibrating video walls it may be advantageous to be able to freely move about without having wires connecting back to the displays. For example, if using a notebook PC, using a wireless connection allows free movement between displays, with only the color sensor connected to the notebook.

Displays can be accessed wirelessly by using a Wireless Router or Access Point connected to the displays as shown in the following example.

Important: Make sure any wireless firewall settings on the computer don't block communications on port 7142.

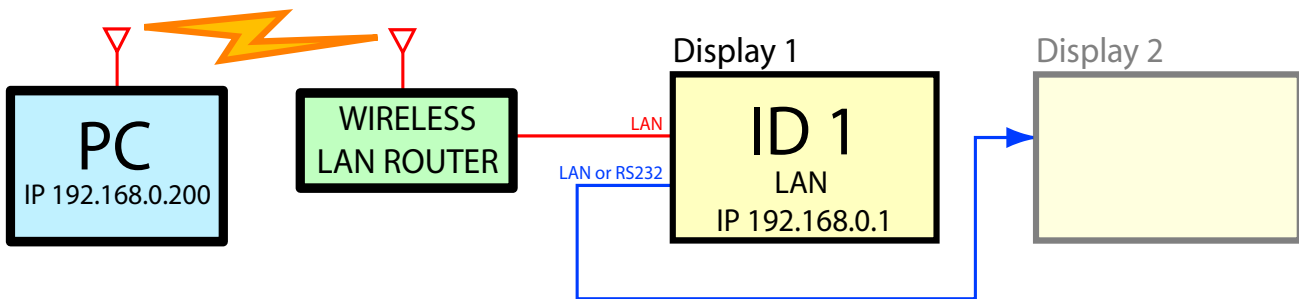

Configuring a Layout with the Layout Wizard

The **Layout Wizard** is accessed from the **Edit** menu and guides the user through the initial layout configuration for the video wall. The wizard will present different options based on the selected connection configuration and the size of the video wall.

On the last page of the wizard, a summary will be shown which provides exact details of the video wall configuration, including the configurations and connections that need to be made to each individual display in the video wall, as well as useful information for troubleshooting the display communications connections and configuration if necessary.

After the wizard is complete, changes to the configuration settings for individual displays can be made, if necessary, using the **Connection** panel.

In this configuration example, a 3x2 video wall uses a LAN connection for communications to the first display and LAN daisy-chaining to the remaining 5 displays.

After starting the wizard, click **Next** to move to the next page.

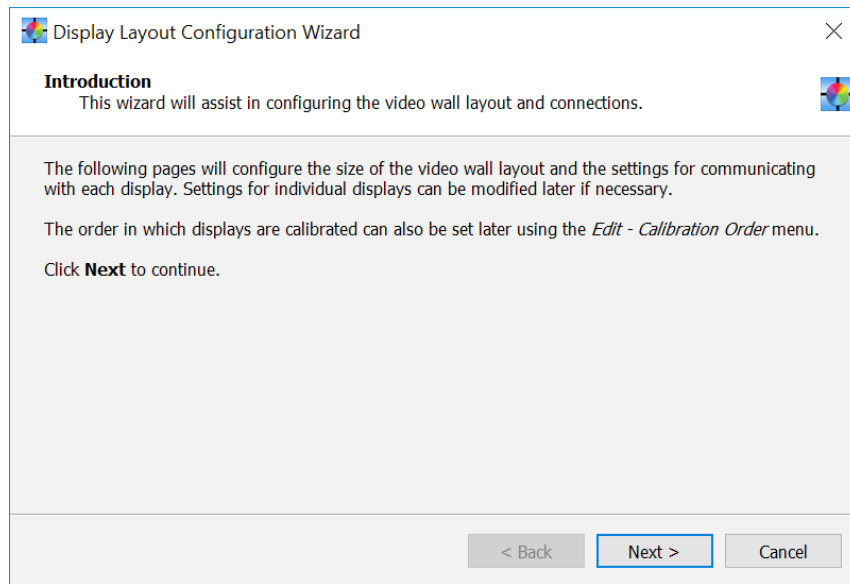

The type of connection configuration available on the displays must be selected in order for the wizard to correctly guide the user through the available connection types. This can be done by either selecting the display model being used from the model list, or by directly selecting the type from the those shown in the connection configuration list.

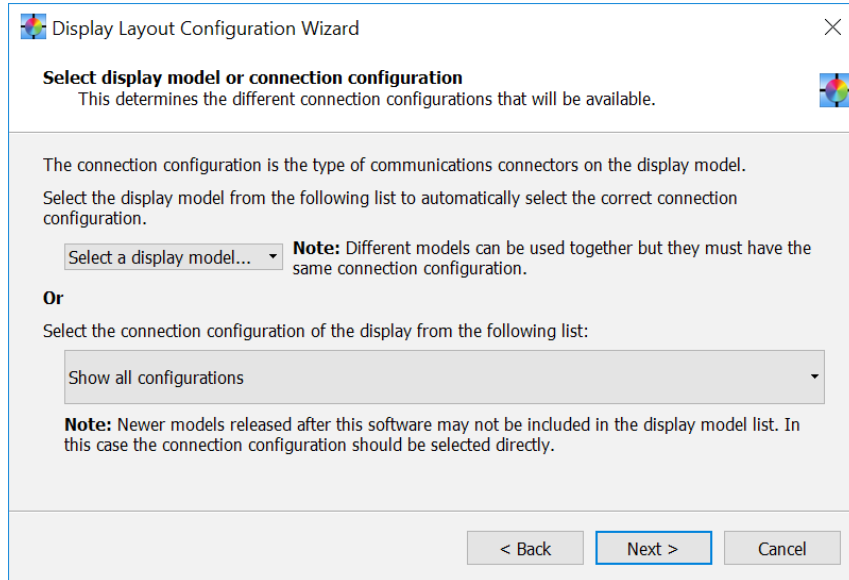

Selecting by display model will automatically select the correct connection configuration. Alternatively, the connection configuration can be selected from the list as shown below.

In this example, a model that has two LAN and one RS232 connections is being selected.

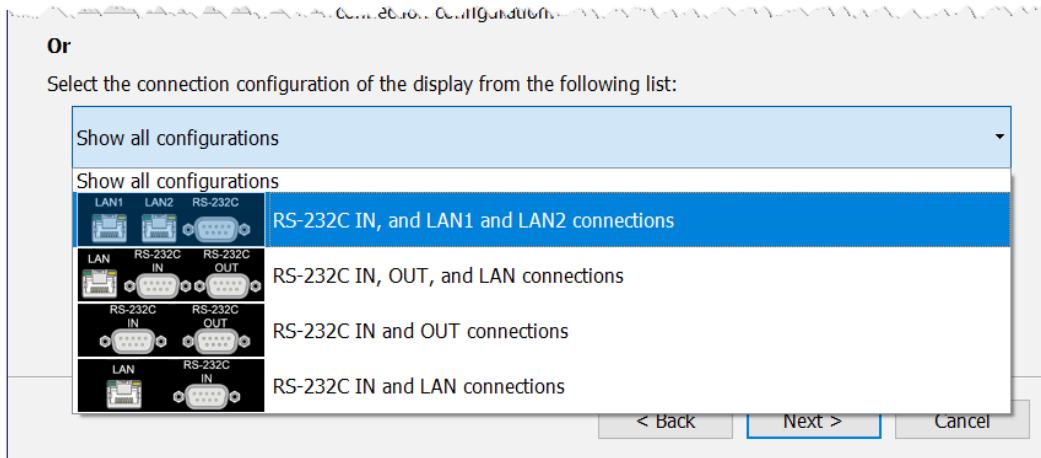

Click **Next** to move to the next page.

Next, the number of rows and columns in the video wall is selected. In this example there are 3 columns and 2 rows.

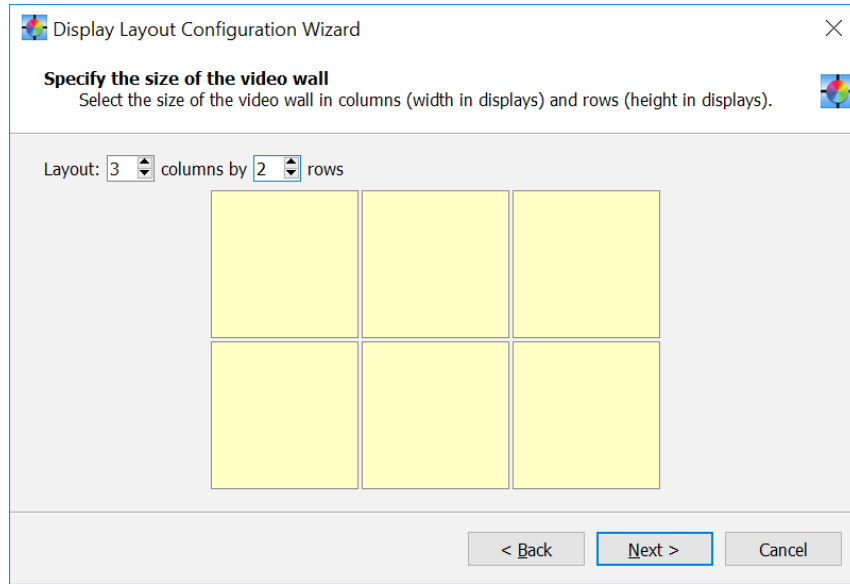

Note: To calibrate a single display that is not part of a video wall, enter a size of 1x1. Up to 30 rows or 30 columns can be selected, but the total number of displays cannot exceed 100.

Click **Next** to move to the next page.

Next, the connection method from the host PC to the displays is selected.

In this example, a LAN connection from the host PC to the first display will be used.

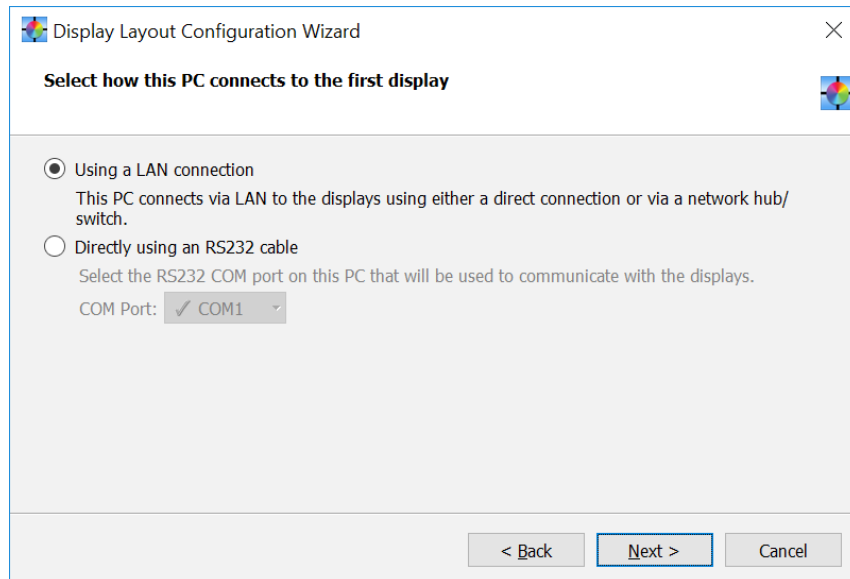

Click **Next** to move to the next page.

Next, the connection method of the other displays in the video wall is selected.

In this example, the remaining 5 displays in the video wall will use the LAN daisy chain to communicate via the LAN connection on the first display.

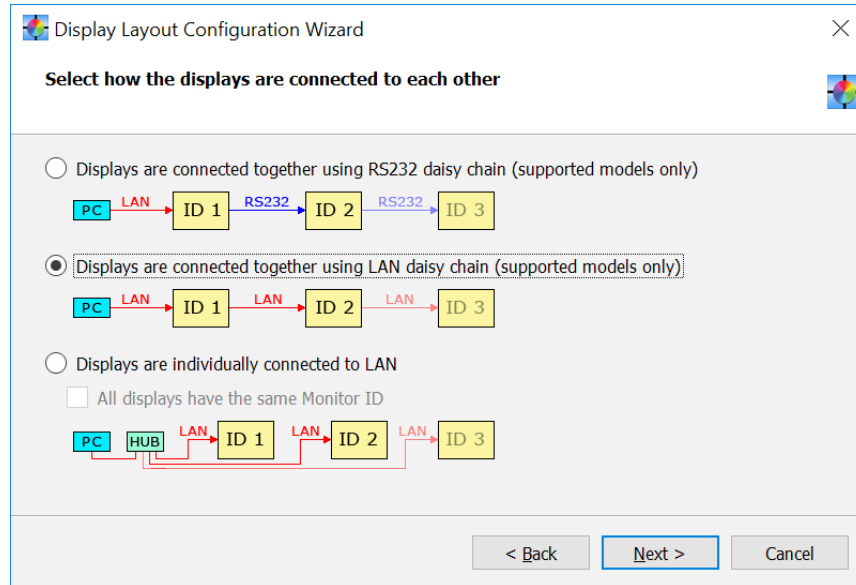

Click **Next** to move to the next page.

Next, select how commands are sent to the displays in the LAN daisy chain. It is recommended to select “Direct to each display” since this allows the fastest operation by using simultaneous communications with each display.

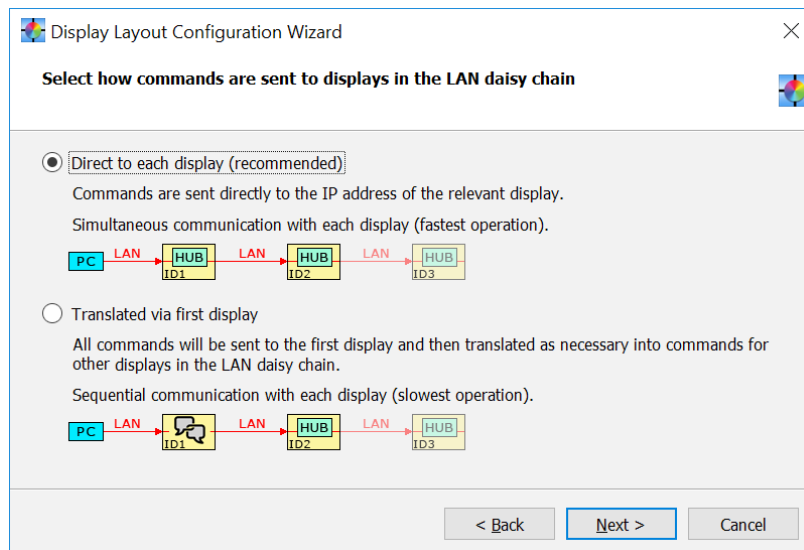

Next in this example, the IP address for the LAN connection on the first display must be entered. For many models connected via LAN, the **Search...** function can be used to locate displays that are connected to the LAN and automatically fill in the correct IP address. See "LAN search" in the "Supported Display Monitors" table on page 8 for models that support this feature.

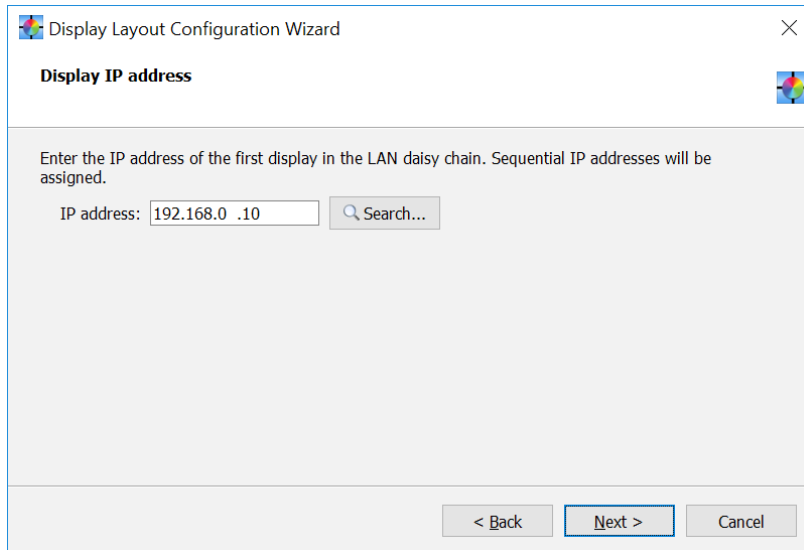

Click **Next** to move to the next page.

Next in this example, the Monitor ID of the first display is entered. The remaining displays in the layout will be assigned sequential IDs.

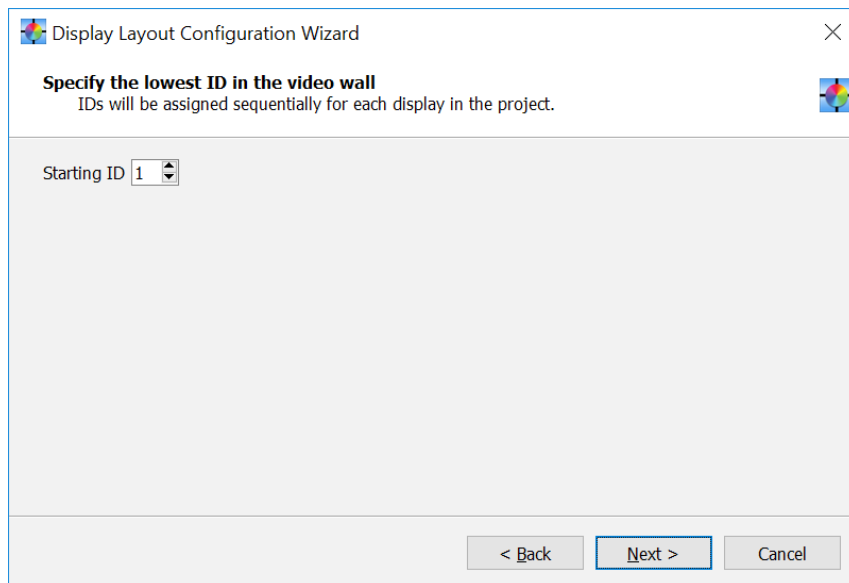

Click **Next** to move to the next page.

Next, the corner location of the first display in the layout will be selected.

This should generally be the display with the lowest Monitor ID, or IP address, so that sequential IDs or IP addresses can be automatically assigned to the rest of the displays. This display will also be the first one to be measured and

calibrated when automatically performing these actions on all displays, however this order can be changed later using the "Calibration Order" on page 50.

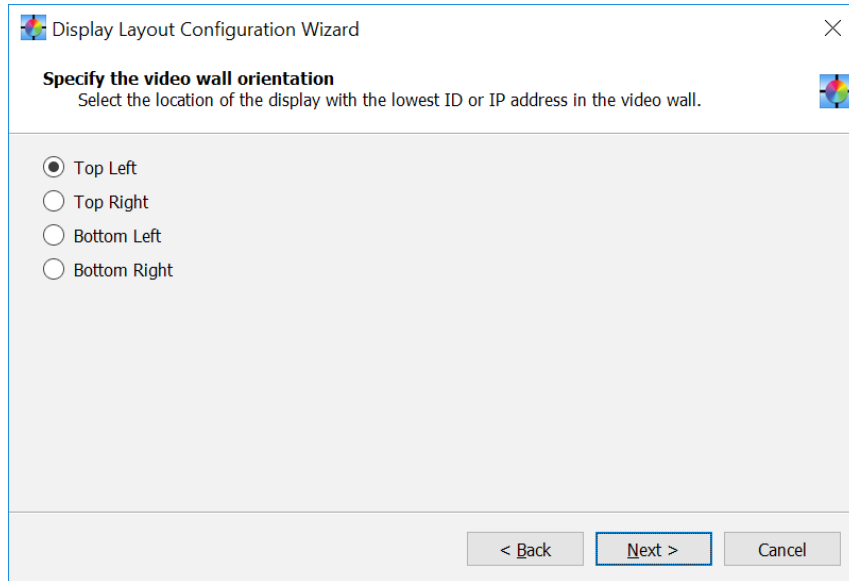

Click **Next** to move to the next page.

Next, the order of remaining displays can be selected. This selection determines how sequential IDs or IP addresses will be automatically assigned to the rest of the displays, and the order of measurement and calibration. Keep in mind that the automatically assigned IDs or IP addresses can be modified later if necessary, as well as the measurement and calibration order.

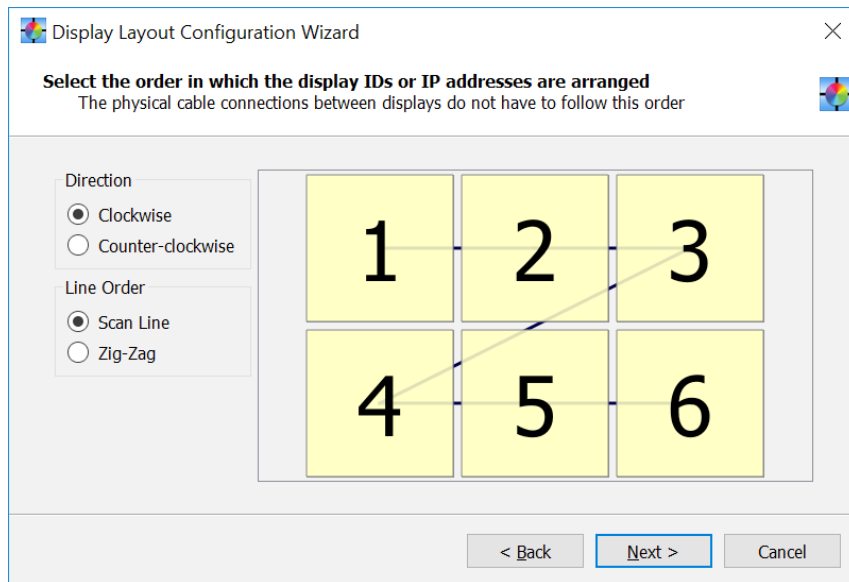

Click **Next** to move to the next page.

Next, the physical orientation of the displays is selected. This selection is used to automatically set the rotation of the OSD (On Screen Display) menu so that it matches the screen orientation, as well as configure other orientation

dependent settings such as corner uniformity. If all of the displays are not in the same orientation, this can be individually set later using the *Main window context menu* (see "Main window context menu" on page 55).

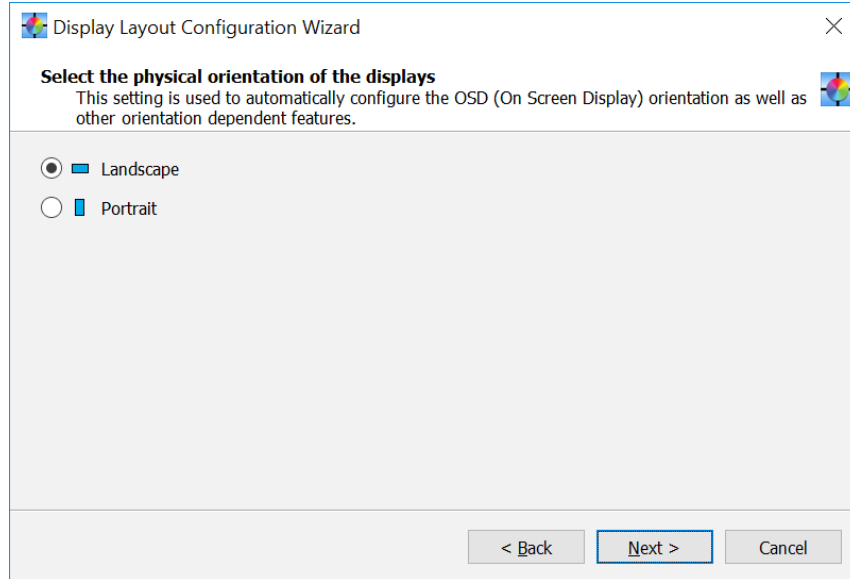

Important: Displays mounted in a portrait orientation should always be rotated 90° clockwise from the landscape orientation for the display's ventilation and cooling to perform correctly.

Click **Next** to move to the next page.

The final page of the wizard shows a summary of the exact details of the video wall configuration, including the physical layout of all of the displays, the configurations and connections that need to be made to each individual display in the video wall, as well as useful information for troubleshooting the display communications connections and configuration if necessary.

This information can be printed or saved to a PDF file for future reference.

Clicking **Finish** will close the wizard and apply the new display layout settings to the current project.

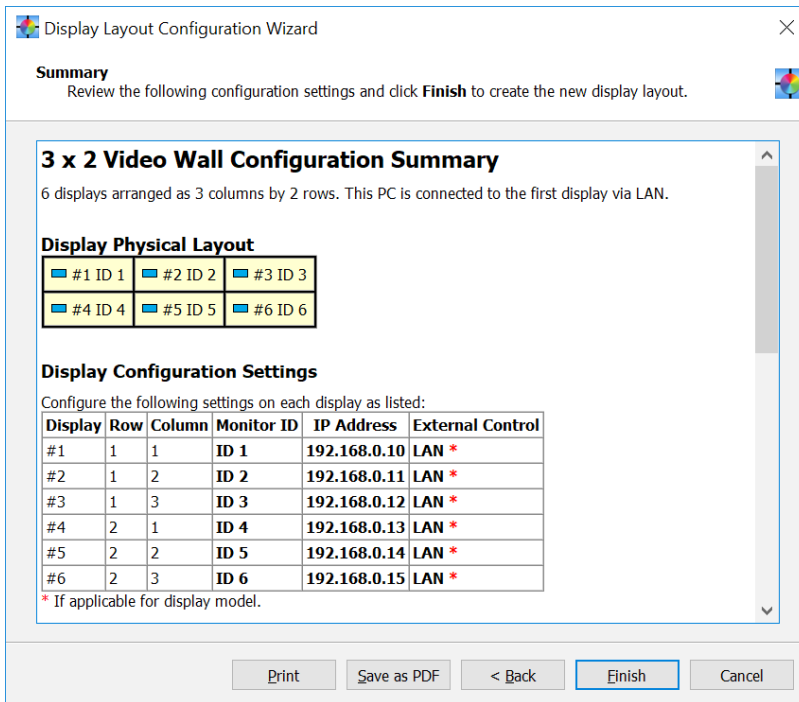

It is possible to see the resulting connection configuration by opening the **Summary** window from the **View** menu.

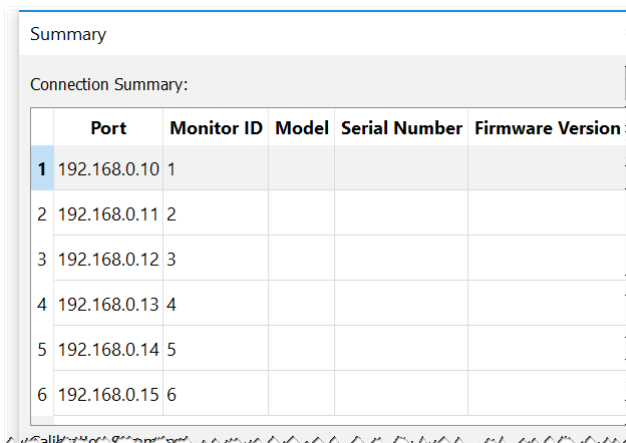

Calibration Order

After the Layout Wizard has been used to configure the layout of the video wall, the order in which operations such as measuring and calibrating displays can be modified using the Calibration Order function.

The Layout Wizard will initially configure the calibration order to be the same order as the IP address or Monitor ID assignments. However, this may not be convenient for efficient calibration since the order may involve excessive operator movement between displays during the process. So, a different order can be selected at any time while maintaining the display connection order.

The **Calibration Order** dialog is accessed from the **Edit** menu.

Click on the display rectangles in the desired order to set a new calibration order. The keyboard arrow keys can also be used to quickly select displays. When all displays have been selected in the desired order, click the **Apply** button.

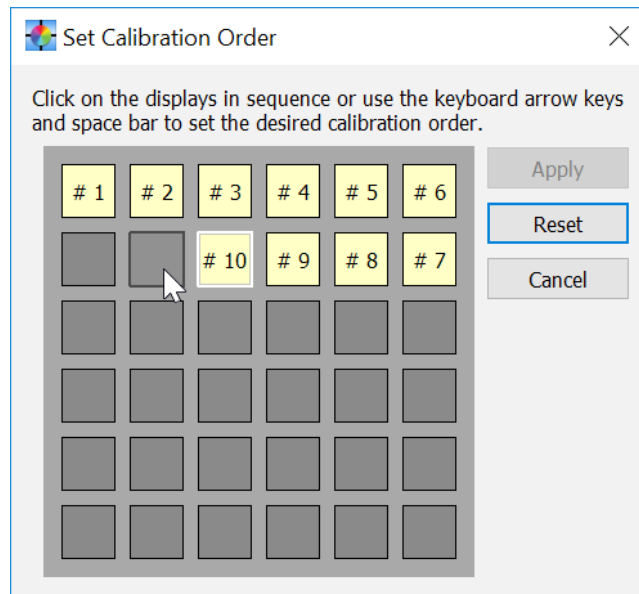

Calibration Times

Once the displays have been connected and configured, and the layout has been configured and verified in the software, the time taken to calibrate the video wall depends on the number of displays, Target parameters, and Preference settings. See "Edit Calibration Target Configuration dialog" on page 56 and "Preferences dialog" on page 60.

Info: For display models that feature the SVE technology, it is possible to calibrate the displays without using a color sensor, which reduces calibration steps and time. See Chapter 11 "Calibrating Without a Color Sensor" on page 123 and Chapter 13 "Calibration Method Comparison" on page 129.

Calibration typically takes about 30 seconds to measure each display, then, once measured, the calibration process takes about 2 minutes per display; however, this can take longer if:

- The **Use LUTs** Calibration Method is used since this measures the grayscale response and transmits the LUT correction data to each display.
- More than the default (32) number of **Grayscale Calibration steps** is selected in the **Preferences**.
- The **Extended Intensity stabilization time** option in the **Preferences** is selected.

Note:

If the Intensity setting in the current Calibration Target is set to Maximum Possible Per Display, it is not necessary to perform the Measurement steps. This is because each display will be calibrated to the maximum possible Intensity that it can achieve and only the white point will match with the other displays. So it is not necessary to first measure all of the displays in order to calculate which is the dimmest display.

Likewise, if **Specific Level** is being used for the **Intensity** setting of the current Calibration Target, and the level value being used can be achieved by *all of the displays at the specified white point*, then the Measurement process can be skipped. For example, if it is known (from a previous set of measurements) that all of the displays can achieve an Intensity of at least 400 cd/m² at a particular White Point, then if a Target Intensity level of 300 cd/m² is used, it would not be necessary to perform the Measurement step.

The following table shows some example typical calibration times for various sized video walls:

Wall Size	Measurement Time (minutes)	Calibration Time (minutes)	Total Time (minutes)
2x2	2	16	18
4x4	8	32	40
5x5	12.5	50	62.5
6x6	18	72	90

Note: When measuring and calibrating the video wall, the software will automatically move to the next display once the current display has been completed. The next display will be indicated by the screen on that display flashing alternating green and red. The software will wait until the color sensor has been placed on the display screen before automatically proceeding with the measurement or calibration process.

Video Inputs

Each video input can have its own settings for various controls, such as Brightness, Gamma Selection, Picture Mode, etc.

During calibration, the settings for the currently selected video input are automatically configured. However, if other video inputs are going to be used as well with the video wall, then the settings for those inputs will need to be correctly configured to use the calibrated settings.

After calibration, use the **Calibration** panel on the **Display Settings** dialog to apply the calibration settings to other video inputs.

Dialogs, Settings and Menus

Main NEC Display Wall Calibrator window

The *NEC Display Wall Calibrator* window shows the current settings and status of the display calibration. All of the features of *NEC Display Wall Calibrator* are accessed from this window.

Some of the main features of this window are shown below.

Actions panel

Controls the main operations of the calibration process.

Connection panel

Shows the communications connection settings for the currently selected display. Settings can be modified if necessary.

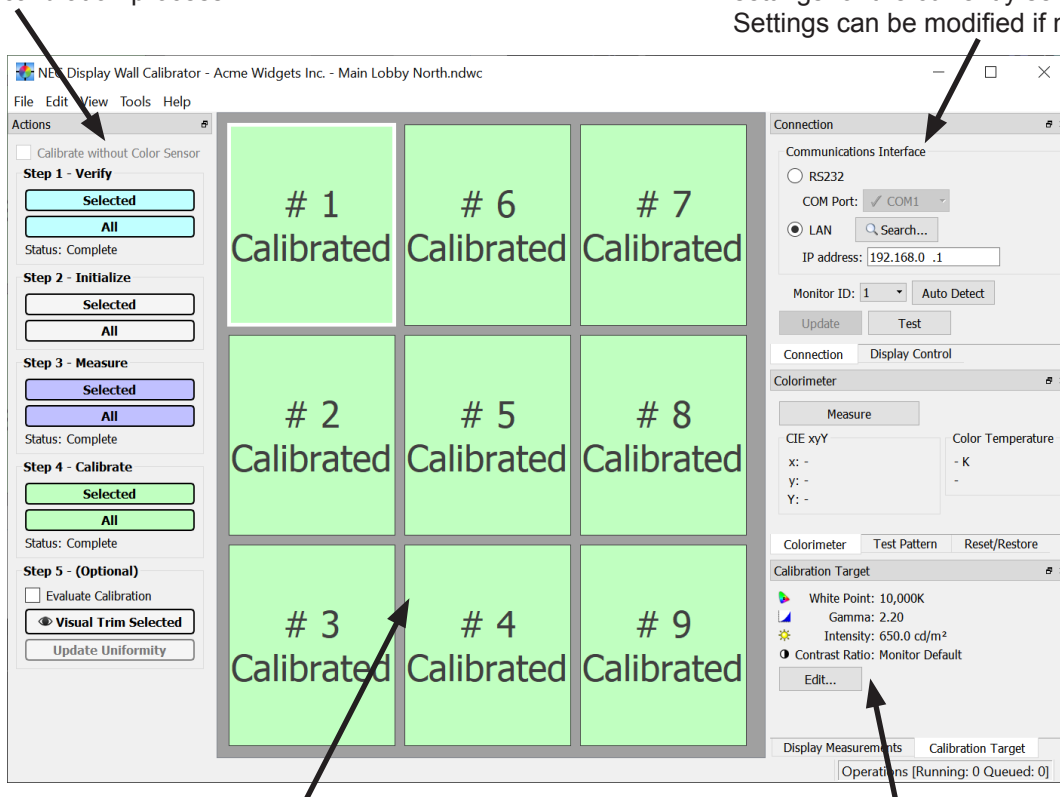

Display layout diagram

Shows a visual representation of the video wall layout. Individual displays can be selected by clicking on a rectangle.

Calibration Target

Shows the current Calibration Target settings. Click **Edit...** to open the *Calibration Target Configuration* dialog box used to modify the Target settings.

The main area in the window shows a visual representation of the current video wall layout. Each rectangle represents a display. The color of the rectangle shows the current status of a particular display. This coloring makes it easy to see the status even when viewing from a distance.

Within each rectangle the display's sequence number is shown. This number is used to identify each display. The number ordering represents the order in which displays will be measured and calibrated when performing operations on multiple displays.

Individual displays can be selected by clicking on a rectangle. The currently selected display is highlighted by a rectangle. The layout, including the number of rows and columns in the video wall and order of the displays, is configured by using the Layout Wizard.

Displays status icons

These status icons are shown within the individual display rectangles in the main window.

 **Visual Trim** - Shown for any displays that have a visual trim adjustment applied to the calibration. See "Visual Trim function" on page 113.

 **Target Offset** - Shown for any displays that have a calibration target offset adjustment applied. See "Calibration Target Offset" on page 80.

 **RGB Gains** - Shown if calibrated using RGB Gains method. See "Preferences dialog - Calibration Method panel" on page 62.

 **SVE detected** - Shown if the display supports calibration via the SVE.

 **SVE calibrated** - Shown if a supported display was calibrated via the SVE.

 **SVE calibrated without a color sensor** - Shown if a supported display was calibrated via the SVE alone (without using a color sensor).

 **SVE disabled** - Shown if a supported display has SVE disabled in the preferences settings. See "Preferences dialog - Calibration Method panel" on page 62.

 **Alert** - Shown if the calibration result is not accurate.

Scale Main View

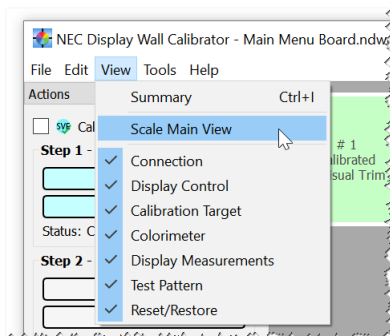

The main area can be scaled so the status of each display is easier to read from a distance. When on, the rectangles will scale to fit the main windows area. For large video walls, the interface will add scroll bars to the main view. When off, each display rectangle is a fixed size.

(Default view)

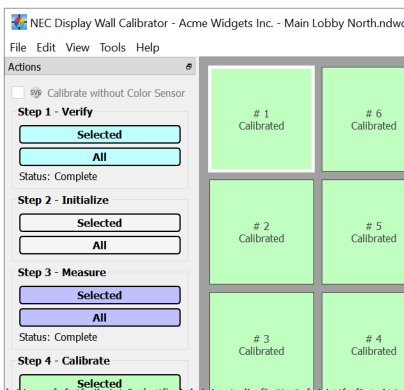

(Scaled view)

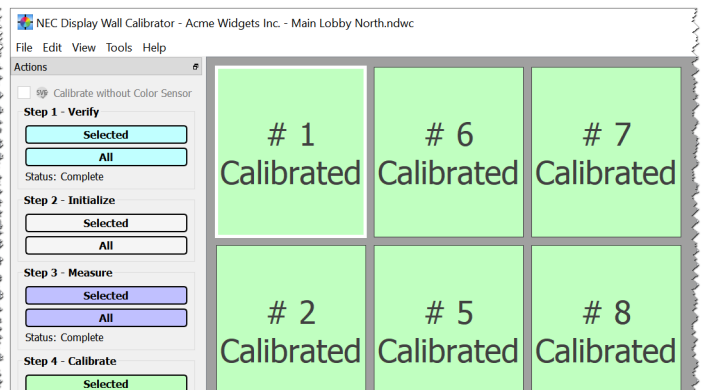

Main window context menu

Each rectangle representing a display can be right-clicked to bring up a context menu for accessing the following functions:

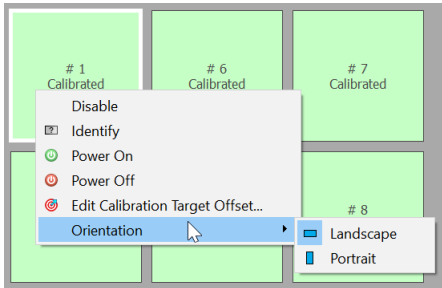

Disable - An individual display can be excluded from the current project by disabling it. To disable a display, right click within the rectangle and select **Disable**. This feature can be used if, for example, the video wall layout is not a rectangular shape.

Identify - An individual display can also be made to flash temporarily so it can be visually identified in the video wall. This is useful to verify that a display is correctly configured and appears at the correct location in the video wall layout. To identify a display, right click within the rectangle and select **Identify**.

Power On and **Off** - An individual display can be powered On and Off by selecting these menu items. The display power can also be set from the "Display Control panel" (see page 74) and the "Display Settings dialog - Power panel" (see page 82).

Edit Calibration Target Offset - An individual display can have a "Visual Trim" adjustment applied to the target. When the display is calibrated again, the "Target + Offset" is used for adjustment. Use the Edit Calibration Target Offset dialog to enable this function and adjust the settings. See "Calibration Target Offset" on page 80.

Orientation - Indicates and selects an individual display's screen orientation (Portrait or Landscape). The orientation setting is used to set the correct OSD rotation, as well as other orientation settings such as Corner Uniformity Correction. See "Visual Trim (calibrated with SpectraView Engine)" on page 115.

Display Information ToolTip

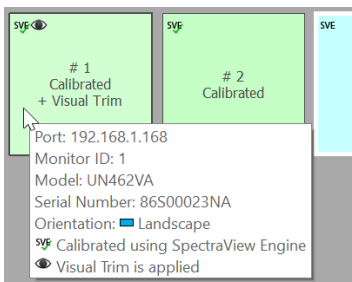

Additional information about a display is shown in a ToolTip by hovering the pointer over a rectangle. This shows the connection information for a display, as well as the Monitor ID, Model Name, Serial Number, and screen Orientation.

Edit Calibration Target Configuration dialog

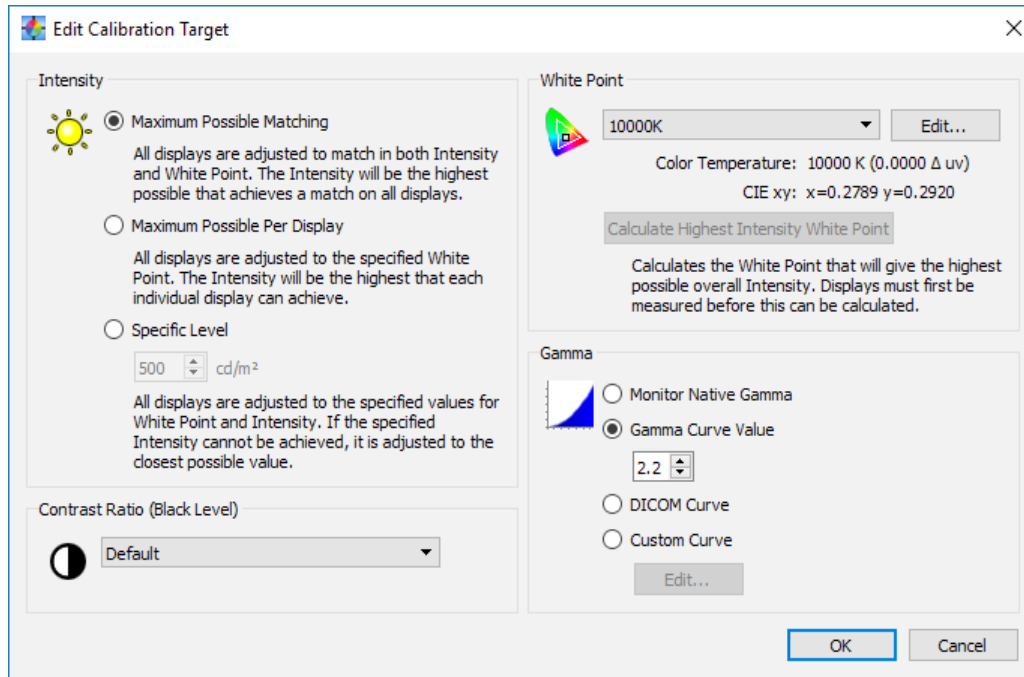

The **Edit Calibration Target** dialog is accessed by clicking the **Edit...** button on the **Calibration Target** panel in the main *NEC Display Wall Calibrator* window, or by selecting **Target...** from the **Edit** menu.

The Target defines the parameters for the calibration process and determines the color characteristics for calibrating each display. Changing the Target settings after calibrating the displays normally means they need to be re-calibrated to the new settings.

Intensity

The **Intensity** selects the luminance or “brightness” of white for the calibration.

Options are:

- **Maximum Possible Matching** - Calibrates all of the displays to the maximum possible luminance that can achieve a match in both Intensity and White Point. Select this option if the user wants all of the displays to match in both color and brightness. All of the displays will only be as bright as the dimmest display.
- **Maximum Possible Per Display** - Calibrates all of the displays to the maximum possible luminance that each individual display can achieve and matches the white points on all displays. Select this option if the user wants all of the displays to match in color but it is not required they match in luminance.
- **Specific Level** - Calibrates all of the displays to a specified target value of luminance and matches the white points. If a display cannot achieve the specified value, it will be calibrated to the closest possible Intensity and a warning icon will be displayed after the calibration has completed. Use this option if your application requires a specific luminance, but keep in mind that each display must actually be capable of achieving that value.

White Point

White Point selects the Target white point for the calibration. Several popular industry standard White Point values, such as 9300K and D65, are provided.

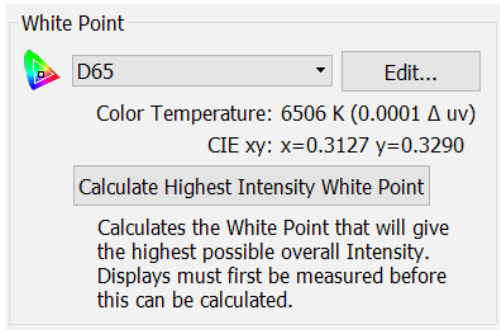

A custom white point can be specified by clicking the **Edit...** button to open up the *Custom Color Temperature* dialog.

If the absolute highest possible Intensity is needed for an application, and the White Point does not need to be a particular value, then the **Calculate Highest Intensity White Point** function can be used to calculate the White Point that gives the highest overall Intensity. This White Point value is calculated from the “native” or un-calibrated measurements taken from all of the displays so all displays should be measured before using this function. Clicking the **Calculate Highest Intensity White Point** button will update the current White Point with the calculated value.

Gamma Curve

Gamma Curve selects the desired tone response curve of the calibrated displays.

Options are:

- **Monitor Native Gamma** - No correction is applied and the display’s Look Up Tables are set to linear.
- **Gamma Curve Value** - The response curve will follow a simple gamma curve. Values between 1.0 and 3.0 can be entered. A gamma value of 2.2 is popular for most applications.
- **DICOM Curve** - The response curve follows the DICOM (Digital Imaging and Communications in Medicine) specification. This response curve is aimed at medical use, however it can be used for other applications. The goal of the DICOM response curve is to have a visually linear display response.
- **Custom Curve** - Advanced and custom response curves can be selected from presets or created by importing a table of values. Click the **Edit...** button to open the **Custom Gamma Curve** dialog.

 **Note:** The Custom Curve and DICOM Curve selections will not be available if the current *Calibration Method* is set to **Use RGB Gains** in the *Preferences*. See "Preferences dialog - Calibration Method panel" on page 62.

Contrast Ratio

Contrast Ratio allows a particular contrast ratio to be used if necessary. The contrast ratio is the ratio of white to black luminance.

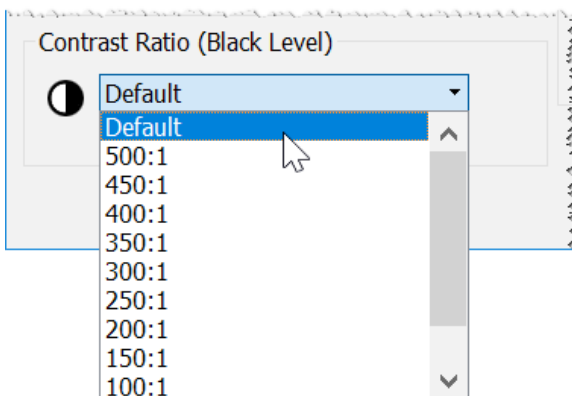

Selecting **Default** will calibrate the display to the highest possible contrast ratio, which is limited by the display technology, the selected White Point, Intensity value, and other factors.

In some applications, simulating low contrast images, such as in newsprint, it is useful to have a lower contrast ratio than the display’s native value. Contrast Ratios in the range of 50:1 to 500:1 can be selected.

 **Note:** The Contrast Ratio selection will not be available if the current *Calibration Method* is set to **Use RGB Gains** in the *Preferences*. See "Preferences dialog - Calibration Method panel" on page 62.

 **Note:** If the selected contrast ratio is higher than what the display is actually capable of achieving, the display will calibrate to the highest possible contrast ratio. If a specific **Contrast Ratio** is selected, it is recommended that the number of **Calibration and Measurement Steps** be set to at least 32 in the *Preferences* dialog.

Custom Gamma Curve dialog

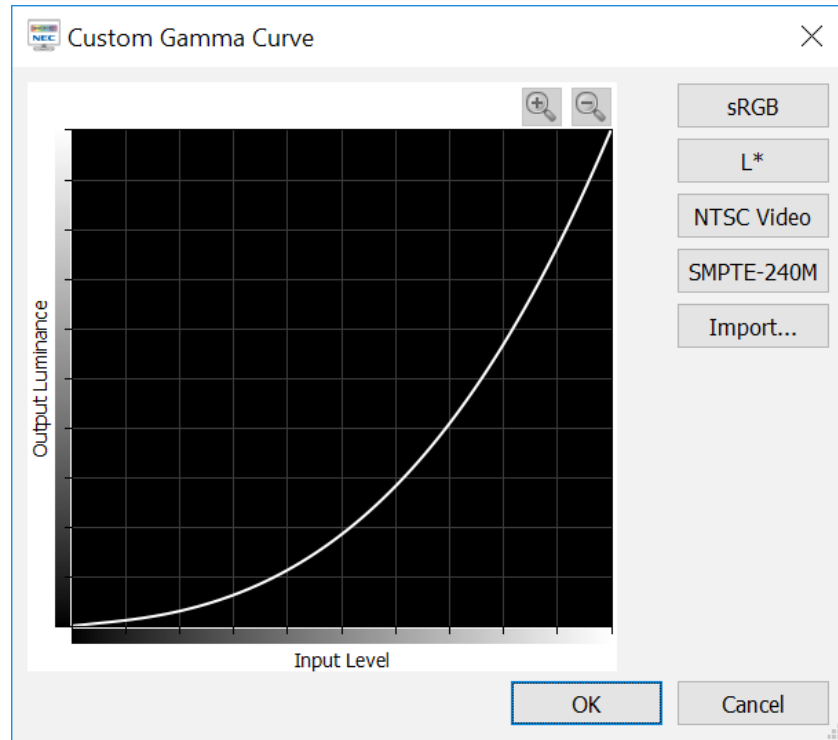

The **Custom Gamma Curve** dialog is accessed by clicking the **Edit...** button in the **Gamma Curve** section of the **Edit Calibration Target** dialog.

Advanced response curves can be selected from presets or custom curves can be created by importing a table of values.

The following preset curves are available:

- **sRGB** - A curve based on the sRGB specification that includes the offset, transition, and slope components.
- **L*** - A curve based on L* in the Lab specification. The L* curve is intended to be more perceptually uniform than a simple gamma value curve.
- **Video** - A curve based on the SMPTE-170M specification for NTSC that includes the offset, transition and slope components. Also suitable for PAL, SECAM and HDTV applications.
- **SMPTE-240M** - A curve based on the SMPTE-240M specification for 1125 line HD video that includes the offset, transition, and slope components.

Custom curves can be created and imported into *NEC Display Wall Calibrator* by creating a text file with a list of numerical values. The text file must conform to the following specifications:

- Must contain between 3 and 256 values.
- Each value must be on a separate line.
- The first value must be 0.
- Values must be monotonically increasing.

When imported, the values will be automatically scaled and interpolated to create a Target curve.

Note: The Custom Gamma Curve option will not be available if the current **Calibration Method** is set to **Use RGB Gains** in the *Preferences*. See "Preferences dialog - Calibration Method panel" on page 62.

Custom White Point dialog

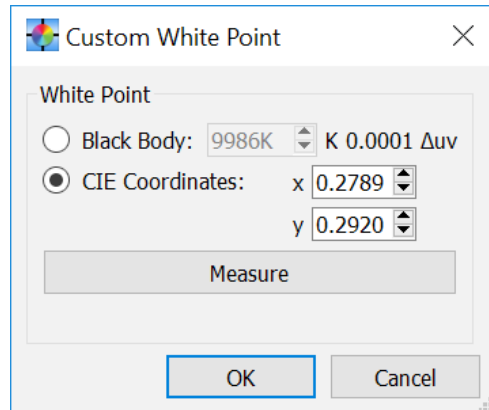

The **Custom White Point** dialog is accessed by clicking the **Edit...** button in the **White Point** section of the **Edit Calibration Target** dialog.

A custom White Point can be created by either specifying it as a **Black Body** radiator temperature in Kelvin, as **CIE (xy chromaticity) Coordinates**, or by taking a measurement.

Values between 2500K and 10000K may be entered in the Black Body K field. The corresponding CIE xy coordinates are automatically calculated and displayed for reference.

CIE xy chromaticity coordinates can be entered by selecting the **CIE Coordinates** radio button and entering the x and y values. The corresponding correlated black body radiator temperature and Δuv (Delta-uv) values are automatically calculated and displayed for reference. The Delta-uv value indicates how far the xy coordinates entered are from the black body radiator locus.

A custom White Point can be measured using the color sensor, and automatically entered in the CIE xy chromaticity coordinate fields, by clicking the **Measure** button. This is useful for “cloning” the white point of another display monitor.

Preferences dialog

The **Preferences** dialog is accessed from the **Edit** menu.

The default settings for the entire Preferences can be restored by clicking the **Defaults** button. This includes any “Don’t show this again” messages that have been selected.

Preferences dialog - Calibration Sensor panel

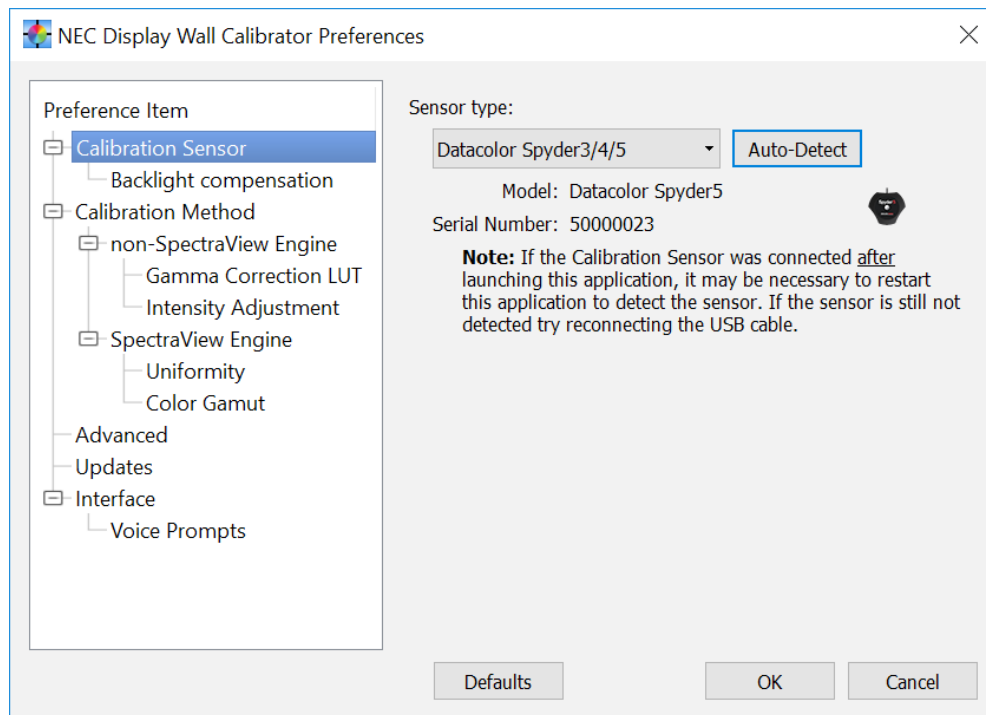

Sensor Type - Selects the model of the color sensor to use and shows the current model being used.

Auto-Detect - Attempts to detect the connected model of the color sensor. *NEC Display Wall Calibrator* will automatically detect the color sensor when the application is started. However, if the sensor was not connected at that time, or if it was being used by another application, then it may be necessary to re-detect it.

Important: If the sensor was not attached when *NEC Display Wall Calibrator* was launched, then it may be necessary to exit the *NEC Display Wall Calibrator* application and launch it again. In some cases it may be necessary to re-connect the USB sensor for it to be detected.

Model and Serial Number - Shows the model and serial number of the currently selected color sensor.

Preferences dialog - Backlight Compensation

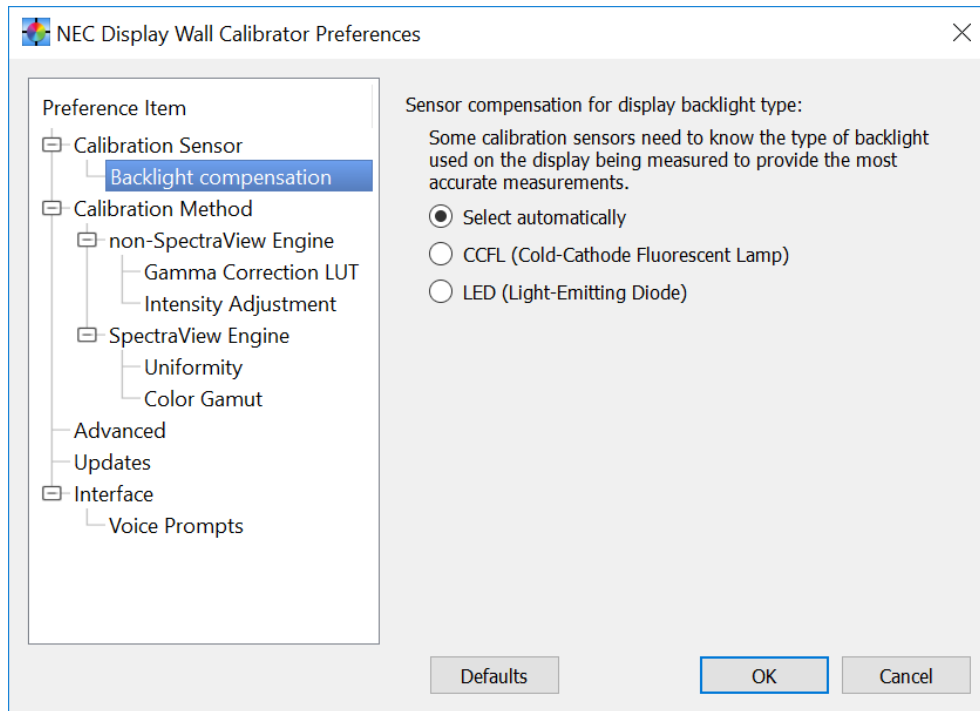

Sensor compensation for display backlight type - Some color sensors need to know the type of backlight used, on the display being measured, in order to provide the most accurate measurements. The software can detect this automatically, or it can be manually set to CCFL (Cold-Cathode Fluorescent Lamp) or LED (Light-Emitting Diode) types.

Preferences dialog - Calibration Method panel

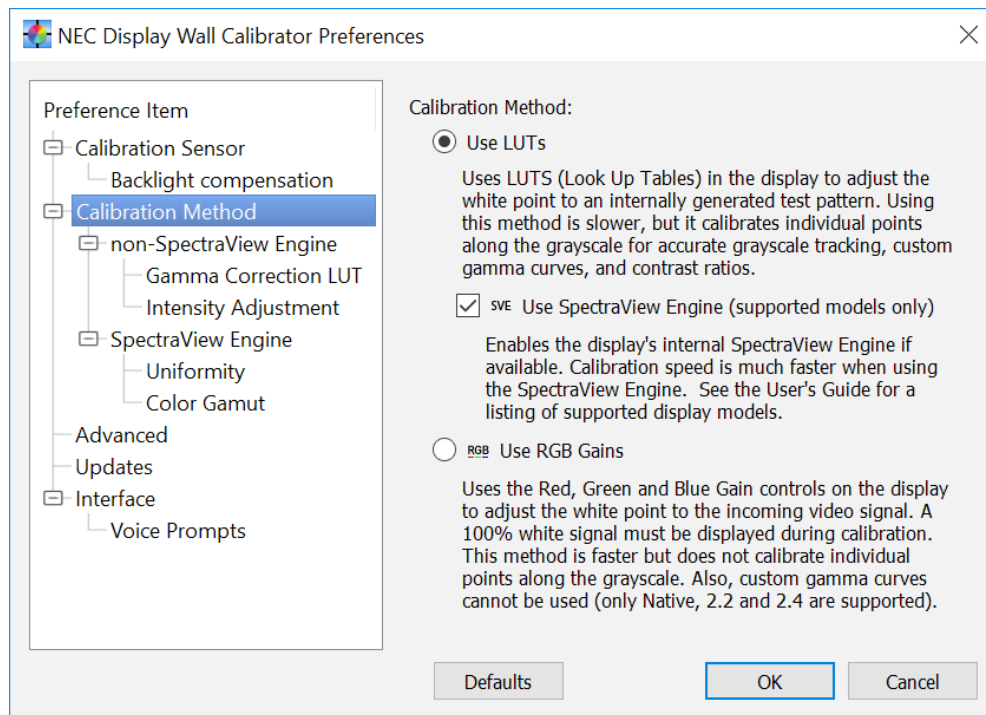

Calibration Method - Selects how the calibration is performed in each display. Options are:

- **Use LUTs** - Uses LUTs (Look Up Tables) in the display to adjust the white point and grayscale correction. It uses an internally generated test pattern when measuring the display. Custom gamma curves and contrast ratios are possible. This method is slower than the *Use RGB Gains* method because there are more measurement steps and the LUT must be transmitted to each display.
 - **Use SpectraView Engine (supported models only)** - Enables the display's internal SVE for faster and advanced calibration by using its internal color processor. This also enables the Uniformity Correction functionality if the SpectraView equipped monitor supports it. For compatible monitors, see "SpectraView Engine (SVE)" and "Uniformity Correction" in the "Supported Display Monitors" table on page 8. See "About SpectraView Engine (SVE)" on page 17 for more information.
- **Use RGB Gains** - Uses the Red, Green and Blue Gain controls on the display to adjust the white point to the incoming video signal. A 100% white video signal must be displayed during the calibration. Custom gamma curves cannot be used and only the fixed Gamma values of 2.2, 2.4 and Native are available. This method is faster than the Use LUTs method, but it does not make any grayscale corrections.

See Chapter 13 "Calibration Method Comparison" on page 129 for detailed information about these options and choosing the best method for the display configuration.

Preferences dialog - non-SpectraView Engine

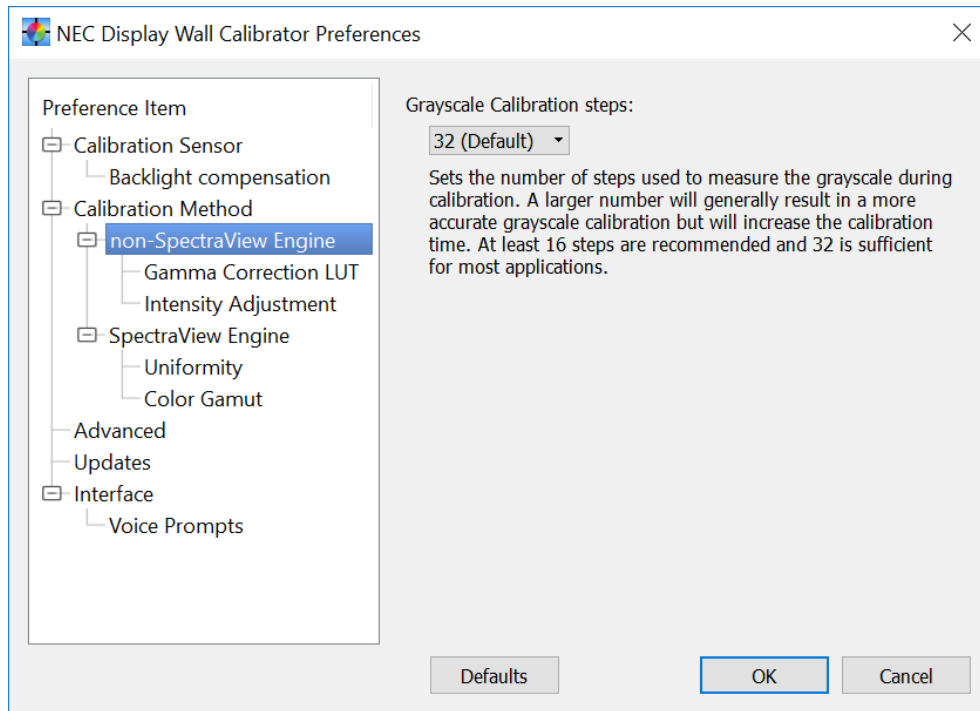

Grayscale Calibration Steps - Selects the number of measurement steps to take when calibrating the display. A larger number of steps will generally result in a more accurate grayscale calibration, but will increase the calibration time. 32 steps is the recommended setting for most applications.

Note: The **Grayscale Calibration Steps** selection will not be available if the current **Calibration Method** is set to **Use RGB Gains**.

Gamma Correction LUT

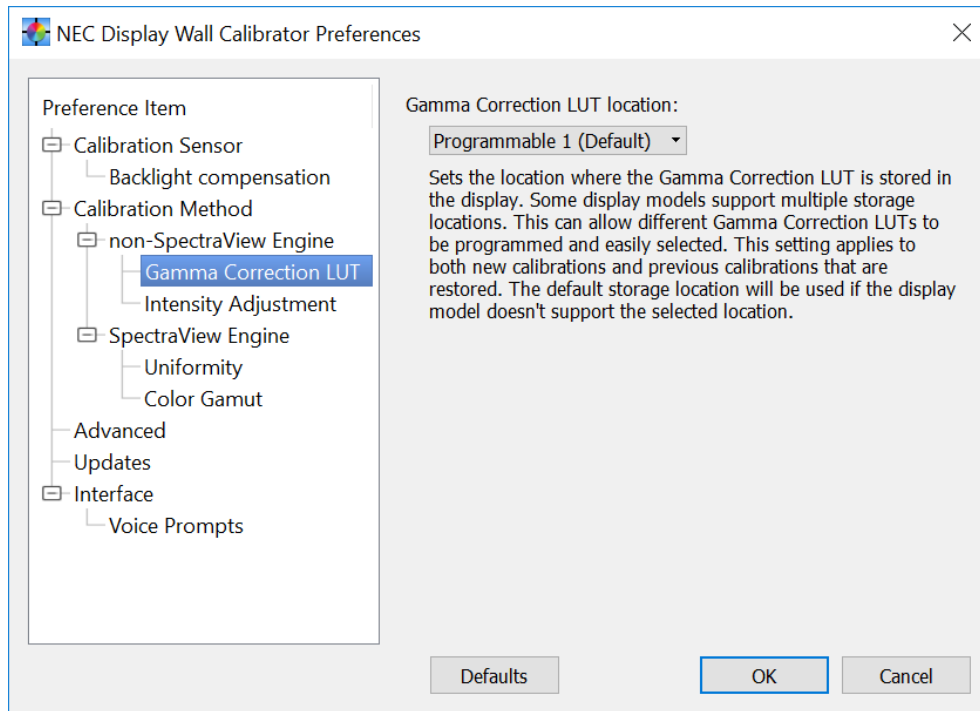

Gamma Correction LUT Location - Sets the location where the Gamma Correction LUT is stored in the display. Some display models support multiple storage locations. This can allow different Gamma Correction LUTs to be programmed and easily selected via the IR Remote or a remote command sequence. This setting applies to both new calibrations and previous calibrations that are restored. The default storage location will be used if the display model doesn't support the selected function.

Note: The gamma **Correction LUT Location** selection will not be available if the current **Calibration Method** is set to **Use RGB Gains**.

Intensity Adjustment

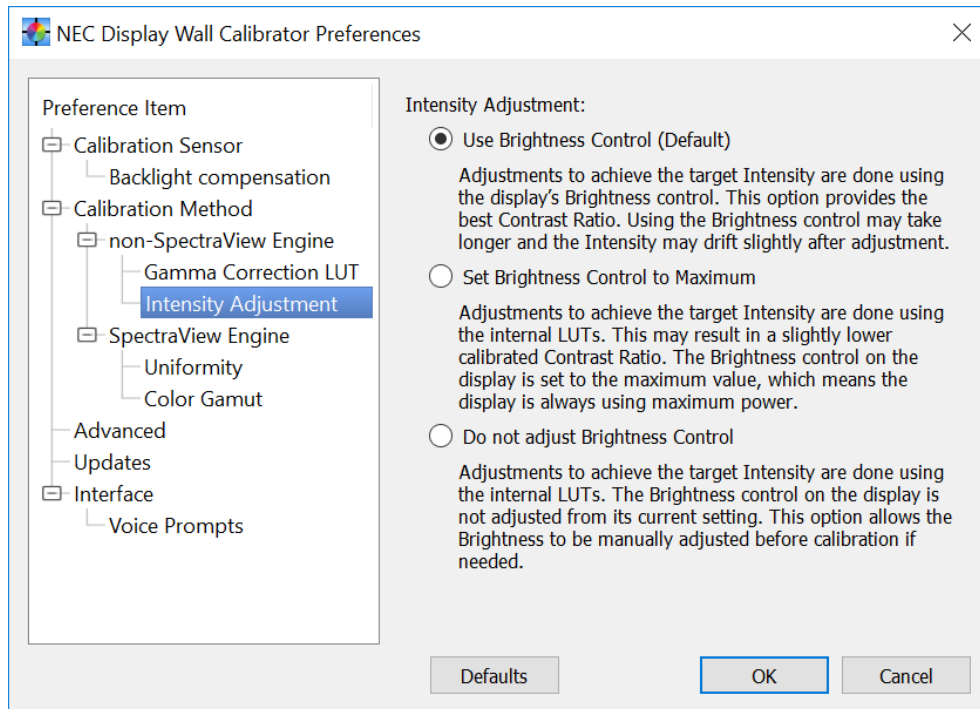

Intensity Adjustment - Sets how a particular Intensity value is achieved during the calibration process if necessary.

Options are:

- **Use Brightness Control (Default)** - The Brightness control on the display is used to achieve the target Intensity. This will provide the best possible Contrast Ratio and lowest power consumption (assuming the target Intensity selected results in the brightness control being reduced from maximum). Adjusting the Brightness control can increase the calibration time slightly, and the Intensity may drift slightly after being adjusted. Because the range of the Brightness control is limited, any additional adjustments necessary to achieve the target Intensity are done using the internal LUTs.
- **Set Brightness Control at Maximum** - The Brightness control on the display is set to the maximum value and any adjustments necessary to achieve the target Intensity are done using the internal LUTs. This may give a slightly lower calibrated Contrast Ratio and the display power consumption is always highest. The calibration time is fastest for this method.
- **Do not adjust Brightness Control** - The Brightness control on the display will not be adjusted from the current setting. Any adjustments necessary to achieve the target Intensity are done using the internal LUTs if possible. This option allows the Brightness to be manually adjusted before calibration if necessary. Since the Brightness control is not adjusted, the Intensity cannot be increased during calibration if necessary.

Preferences dialog - SpectraView Engine

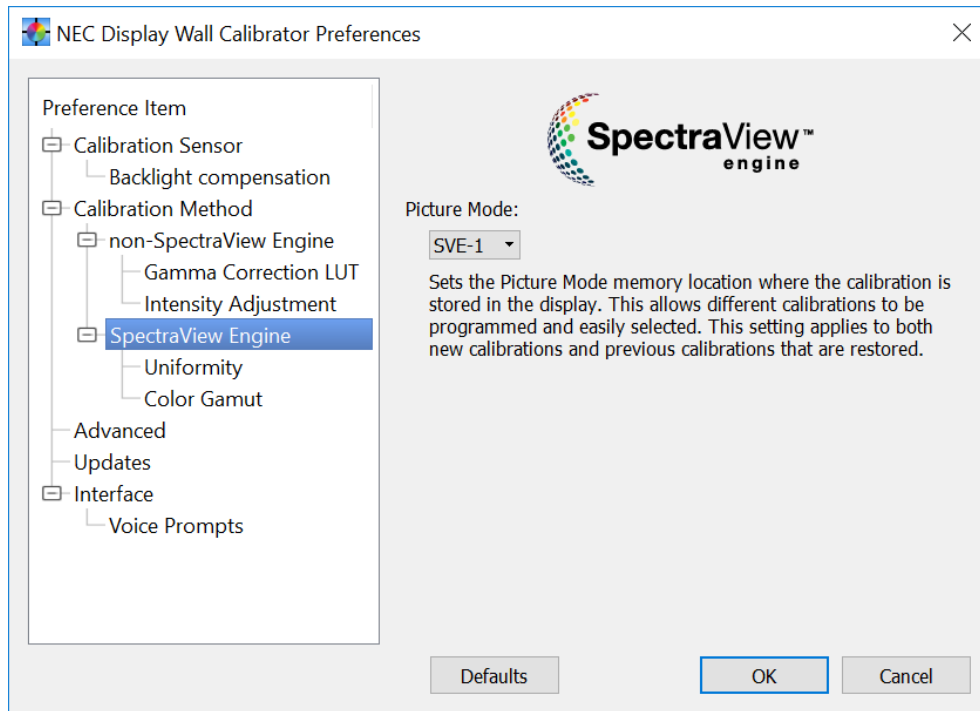

Picture Mode - Sets the Picture Mode memory location where the calibration is stored in the display. Up to five calibrations can be programmed and easily selected. This setting applies to both new calibrations and previous calibrations that are restored.

When calibrating the display, select the Picture Mode to store the calibration data.

When restoring a calibration, the calibration settings will be restored to the currently selected Picture Mode preference setting. Use the Reset/Restore panel (see "Reset/Restore panel" on page 76) to restore the calibration data to the currently selected Picture mode. This feature allows calibrations to be restored to different Picture Modes than the one used for calibrating. Different calibrations can then be instantly switched by changing the Picture Mode.

Uniformity

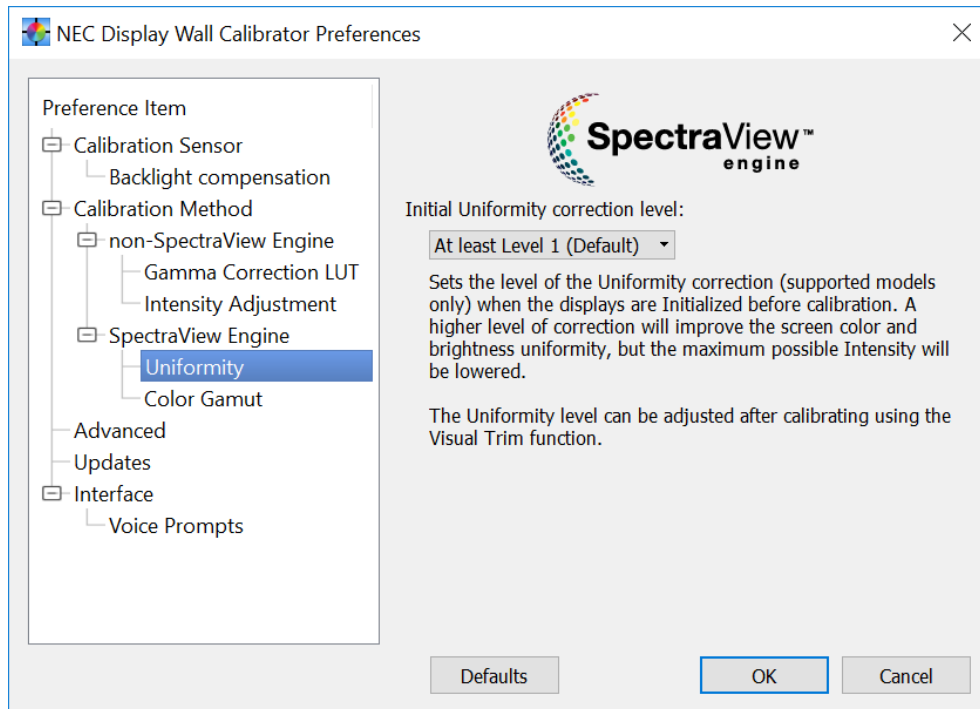

Initial Uniformity correction level - Sets the level of the Uniformity correction when the displays are Initialized before calibration. A higher level of correction will improve the screen color and brightness uniformity, but the maximum possible Intensity will be lowered. See "Uniformity Correction" in the "Supported Display Monitors" table on page 8 for models that support this feature.

If the video wall setup requires maximum Intensity (brightness) and screen uniformity is not necessary, selecting "Off" will disable the Uniformity correction in the display. However, if achieving the best possible screen uniformity is required and some Intensity can be sacrificed, it is recommended to use the default setting or higher.

Note: This setting is only applied when the displays are Initialized before measurement and calibration. The impact of the Uniformity setting reducing the display Intensity will be factored into the maximum matching Intensity calculations for the video wall. The Uniformity level can be adjusted after calibrating using the Visual Trim function. See Chapter 8 "Visual Trim function" on page 113.

Color Gamut

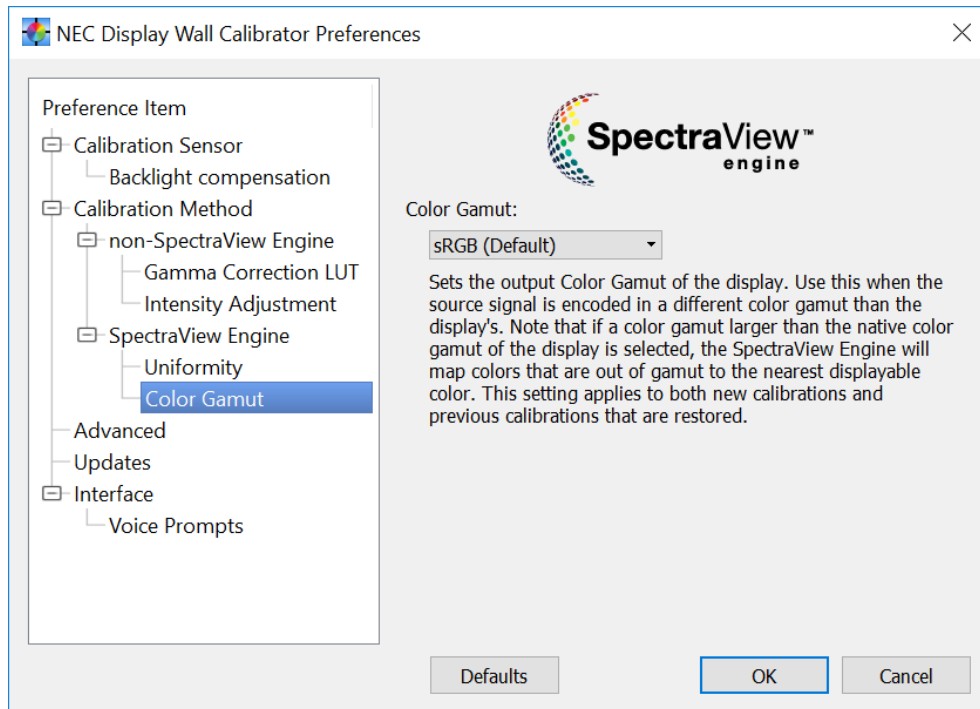

Color Gamut - Sets the output Color Gamut of the display. Use this when the source signal is encoded in a different color gamut than that of the native display's. Note that if a color gamut larger than the native color gamut of the display is selected, the SpectraView Engine (SVE) will map colors that are out of gamut to the nearest displayable color. This setting applies to both new calibrations and previous calibrations that are restored.

Preferences dialog - Advanced panel

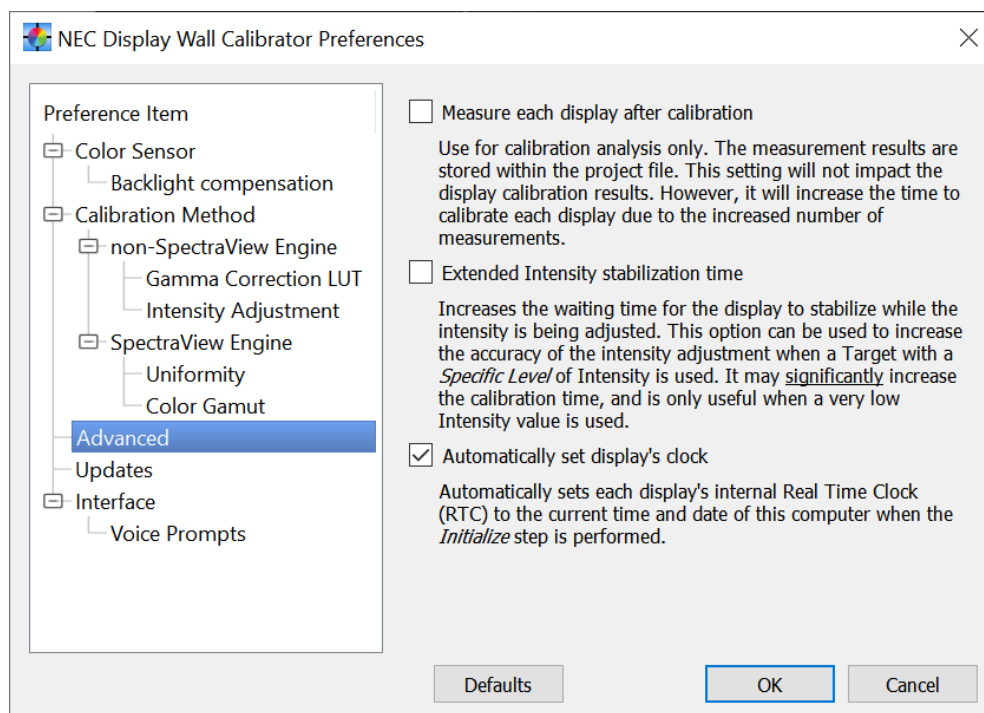

Measure each display after calibration - Selecting this option will measure each display after it has been adjusted during calibration. This is for calibration analysis purposes only. It will not impact the display calibration other than increasing the overall calibration time due to the increased number of measurements. Use this option only when asked to do so in order to provide calibration accuracy results for analysis purposes. The measurement results are stored within the project file.

Extended luminance stabilization time - Increases the waiting time for the display to stabilize while the luminance is being adjusted using the Brightness control. This option can increase the accuracy of the luminance adjustment when a Target with a Specific Level of Intensity is being used. It may significantly increase the calibration time and is normally only useful when a very low intensity value is specified. Try selecting this option if the Intensity measured after calibration is significantly different than the Target value, due to the display stabilizing during the calibration and profiling steps.

Automatically set display's clock - Automatically set each display's internal Real Time Clock (RTC) to the current time and date.

Preferences dialog - Updates panel

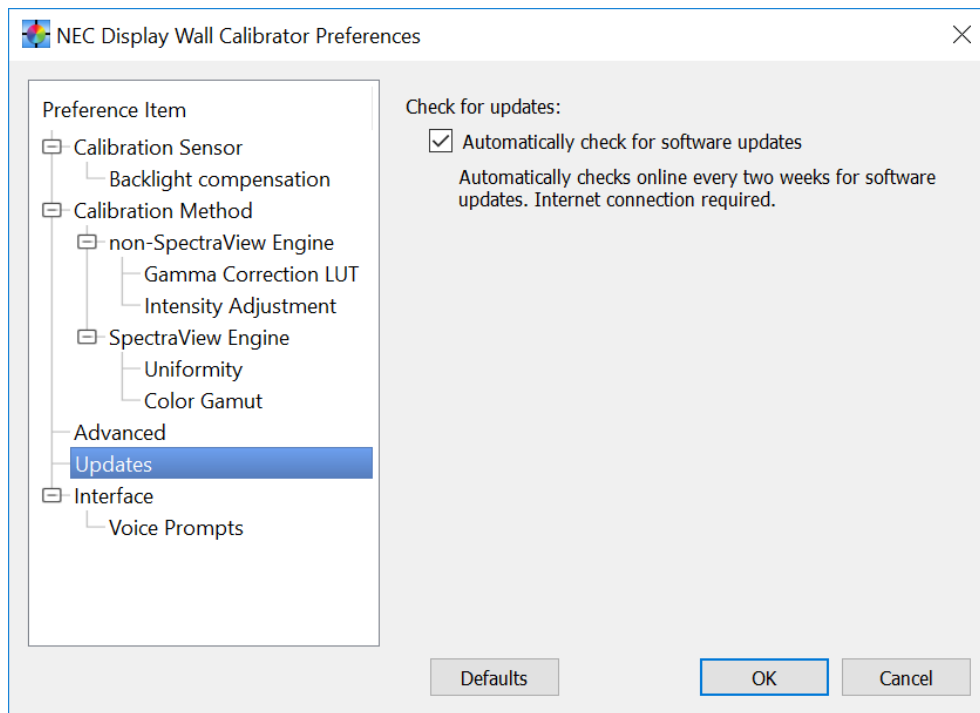

Check For Updates - When selected, the software will automatically check every two weeks when run to see if a new version is available online. An Internet connection is required.

Note: The software can be manually updated at any time from the **Help** menu option **Check for updates**.

Preferences dialog - Interface panel

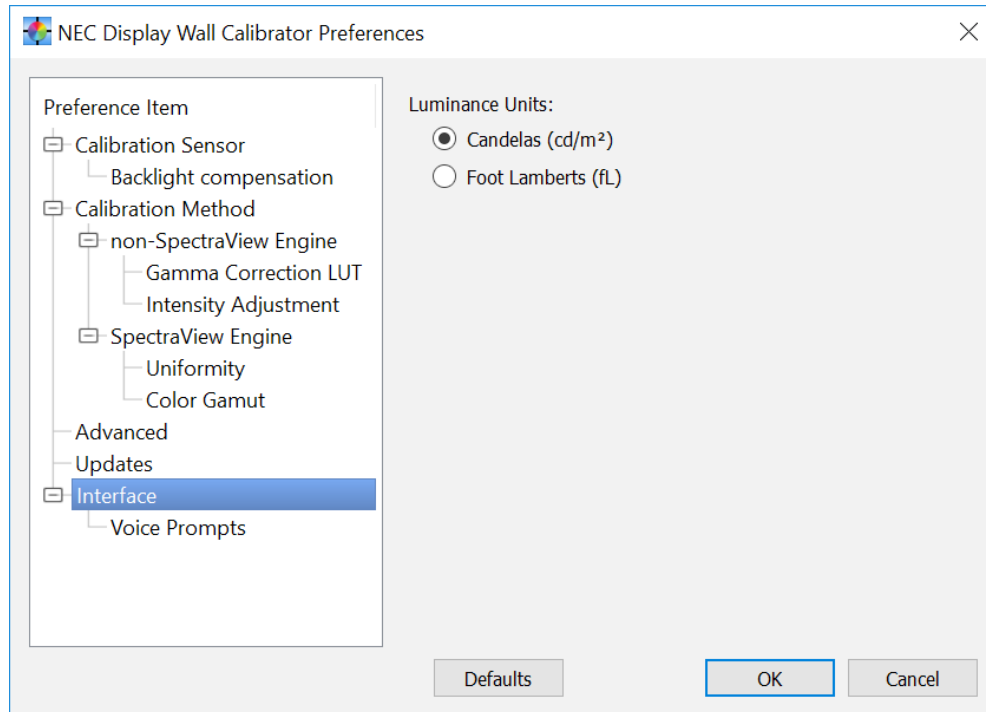

Luminance Units - Selects the units that luminance values are displayed in. Options are:

- **Candelas (cd/m²)**
- **Foot Lamberts (fL)**

Preferences dialog - Voice Prompts

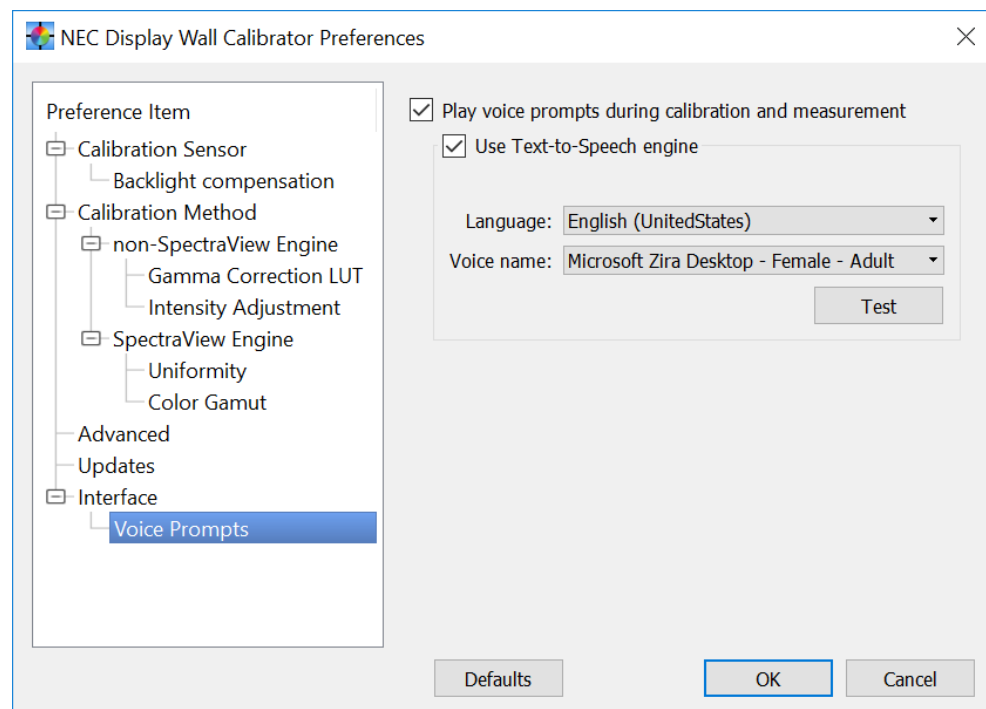

Play voice prompts during calibration and measurement - When selected, the software will play voice prompts during the calibration process indicating when to position and remove the color sensor from the display screen. This is useful when it is not practical to look at the application while the displays are being calibrated. A PC with sound output capabilities is required.

Use Text-to-Speech engine - When selected, the operating system's TTS engine is used for voice prompts during calibration. Using the TTS engine provides more detailed voice prompts and different voices can be selected.

 **Note:** (Windows version only) Different TTS voices can be installed on Microsoft Windows via the Windows Control Panel. Clicking the **Test** button will speak a test sentence.

Panels

Various Panels are available within the main window for controlling the operation of the software.

Panels can be closed by either selecting them from the **View** menu or clicking the "close" icon on each panel. Panels can also be rearranged and moved outside of the main window, if desired, by dragging the title bar of the panel.

The functions of each panel are described in detail below:

Actions panel

This panel is used to perform the major operations in the application. Each step can be run for just the selected display or all displays in the video wall. The various buttons will be disabled and enabled depending on the stage of the calibration process. Generally, operations for calibrating the display are done in the same order as the steps indicated on-screen, as described below.

i Info: If the display model features the SVE and the option "Calibrate without Color Sensor" is selected, the number of calibration steps is reduced to Verify, Calibrate, and (optionally) Visual Trim. See Chapter 11 "Calibrating Without a Color Sensor" on page 123.

To prevent loss of data, the software will prompt to save the project before starting measurement and calibration.

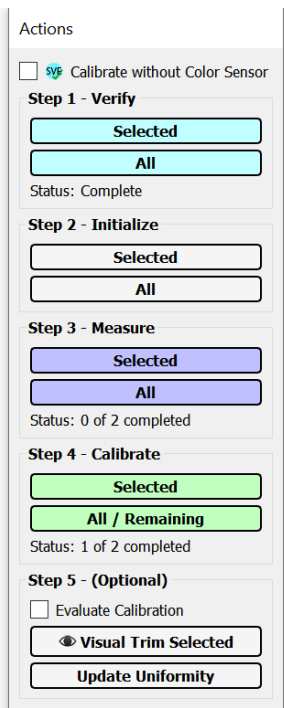

Step 1 - Verify - This will attempt to communicate with the display(s) in order to verify that all are accessible and correctly configured. If a display fails this step, follow the instructions in "Troubleshooting" on page 110. Once all displays have been verified, it is possible to go on to the Initialize step.

Step 2 - Initialize - This will reset the display(s) to the default color settings so the "native" performance of each display can be measured before the calibration. Settings such as the Brightness, Color mode, Contrast, etc., will be reset.

Step 3 - Measure - This will measure the default "native" color characteristics of the display(s). These measurements will determine the maximum possible Intensity that will give a color match with all of the displays. The user will be prompted to place the sensor on the screen while the software displays various test patterns and takes measurements.

When measuring **All / Remaining** displays, the user will be instructed when to move the color sensor to the next display. The displays will be measured sequentially. There is no need to interact with the host PC while the displays are being measured. The next display is selected automatically and the routine will wait until the color sensor is placed on the screen indicated. This is useful if it is not convenient to have the host PC nearby; for example, when standing on a ladder.

Note: If one or more of the displays have already been measured and **All / Remaining** is clicked, the user will be asked if they want to measure just the remaining unmeasured displays or re-measure all of the displays.

Step 4 - Calibrate - This will calibrate the display(s) to the Target settings. The user will be prompted to place the sensor on the screen while the software displays various test patterns and makes adjustments.

When calibrating **All / Remaining** displays, the user will be instructed when to move the color sensor to the next display. The displays will be calibrated sequentially. There is no need to interact with the host PC while the displays are being calibrated. The next display is selected automatically and the routine will wait until the color sensor is placed on the screen indicated. This is useful if it is not convenient to have the host PC nearby; for example, when standing on a ladder.

 **Note:** If one or more of the displays have already been calibrated and **All / Remaining** is clicked, the user will be asked if they want to calibrate just the remaining un-calibrated displays, or re-calibrate all of the displays.

Step 5 - (Optional)

Evaluate Calibration - This feature shows the post calibration white test patterns, including any visual trim adjustment. The test patterns will remain on even after Visual Trim adjustment of the display. This makes it easier to evaluate the video wall and keep the test patterns showing. De-selecting this option will turn off the test patterns. This option is not available when using RGB Gains for the Calibration Method.

Visual Trim Selected - This feature can be used to manually fine-tune overall color, screen uniformity, and corner uniformity for the selected display by adjusting the color visually. It is useful, for example, when the automatic color sensor based calibration doesn't match the displays perfectly.

Update Uniformity - This feature can be used to improve the effectiveness of the Uniformity Correction feature for an individual display by updating the original factory uniformity measurements with measurements taken from your color sensor. This feature is only available if the selected display supports this feature (see "Update Uniformity Correction" column in the "Supported Display Monitors" table starting on page 8). See Chapter 9 "Update Uniformity" on page 118.

Action button ToolTips

Each button has a ToolTip which shows the steps and conditions necessary for it to be enabled. Hold the cursor over a button and the ToolTip will list the conditions. A green check mark ✓ indicates that a condition has been met. A red cross mark ✗ indicates that a condition has not yet been satisfied. When all conditions have been satisfied the button will be enabled.

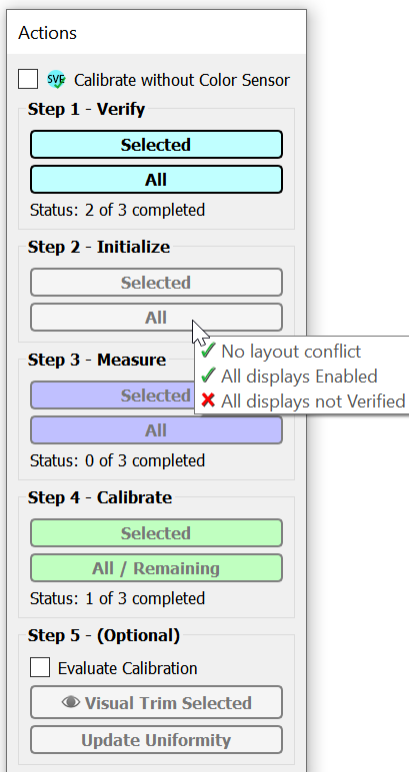

Display Control panel

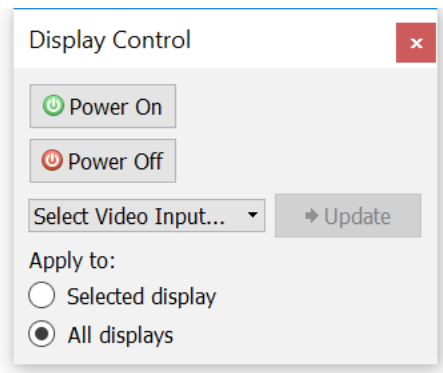

This panel provides easy access to control the power state and *Video Input Signal* for the displays.

These functions can be applied to the selected display or to all displays by selecting the appropriate setting in **Apply to:**.

Connection panel

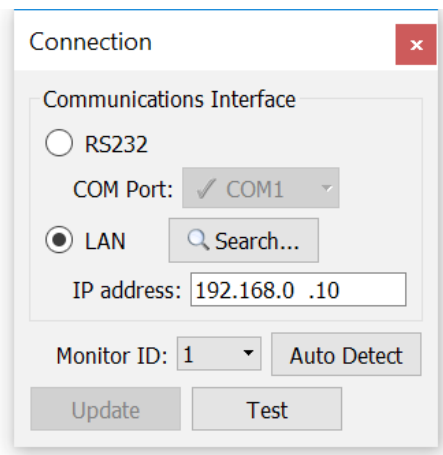

This panel is used to modify the communications connection settings for the currently selected display in the layout.

Connection types of **RS232** or **LAN** (Ethernet) can be selected.

If using RS232, the RS232 COM port on the host PC used to communicate with the displays can be selected. Currently available COM ports on the host PC are listed in **COM Port:**.

If using LAN, the **IP Address** of the display can be entered. For many models connected via LAN, the **Search...** function can be used to locate displays that are connected to the LAN and automatically fill in the correct IP address. See "LAN search" in the "Supported Display Monitors" table on page 8 for models that support this feature. See Appendix A "Assigning an IP address" on page 131 for instructions on how to assign the IP address for each display.

For both communications types, the **Monitor ID** of the display must be selected and match the ID selected on the display's OSD setting. If displays are daisy-chained together using RS232, each display must have a unique Monitor ID assigned that matches the display's OSD setting.

Click **Auto Detect** to query the monitor ID of the display on the currently selected Communications Interface. If the displays are daisy chained together, the Monitor ID of the first display will be selected.

The communications settings and link to the display can be tested by clicking the **Test** button. This will attempt to communicate with the display on the selected communications interface and Monitor ID.

Clicking the **Update** button will update the communications connection settings for the currently selected display in the layout.

 **Note:** If changes have been made, but the **Update** button has not been clicked, the changes will be lost if another display is selected in the layout.

 **Note:** (Windows version only) COM ports 1-16 are listed, regardless of if they are installed on the system. COM ports that are reported as available by Windows are shown with a green check mark ✓, and COM ports reported as unavailable are shown with a red cross mark ✗.

Colorimeter panel

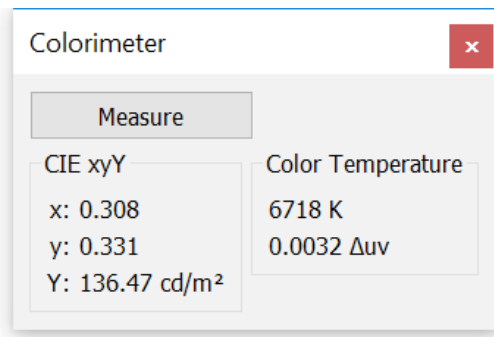

This panel is used to take color measurements of the screen with the color sensor and then display the numerical results.

To take color measurements using the Colorimeter, display a white image or test pattern on the screen to be measured and place the color sensor on the screen. Then click the **Measure** button to take a single color measurement and display the results.

The measurement results are shown in **CIExyY** and **Color Temperature**.

The **Color Temperature** field shows the corresponding correlated black body radiator temperature of the measurement in Kelvin. The Δuv (Delta-uv) value indicates how far the measurement is from the blackbody radiator locus. The Kelvin value is only meaningful for colors that are near the black body radiator locus, such as most shades of white.

This feature can be used together with the **Test Patterns** tool to verify the calibration accuracy of a display. In this case the **Calibrated White** function in the Test Pattern panel can be used to show a calibrated white screen, then the sensor can be used to measure the screen.

It can also be used to measure the native white point of a display by using the **100% White** function in the Test Pattern panel to show a native white screen, which can then be measured using the sensor.

Test Pattern panel

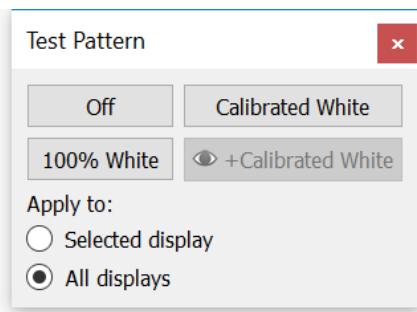

This panel is used to display test patterns on either the currently selected display, or all of the displays in the layout.

Test patterns can be used to visually evaluate the displays both before and after calibration.

Three patterns are available:

100% White, **Calibrated White**, and **Visual Trim+Calibrated White**.

The **100% White** pattern is native white with no correction applied by the calibration.

The **Calibrated White** pattern is only available if the display has been calibrated. It displays the adjusted white color achieved after calibration and is useful to visually evaluate the calibration accuracy. This does not apply any Visual Trim adjustments made to any of the displays, so the resulting test pattern shows the results achieved by automatic calibration alone.



The (Visual Trim) **+Calibrated White** pattern is the same as Calibrated White, however, any adjustments made using the *Visual Trim* feature are also applied.

Off will turn off the test patterns and normal video will be shown.

Apply to: selects if the Test Patterns will be shown on either the *Selected Display* only or *All Displays*.

Important: Since there is a slight color shift with viewing angle, when evaluating the color calibration uniformity across multiple displays, be sure to stand as far back as possible from the video wall and evaluate from directly in front of the screens.

Note:

- The **Calibrated White** and (Visual Trim)  + **Calibrated White** buttons will not be available if the current **Calibration Method** is set to **Use RGB Gains** in the **Preferences**. In this case a white video signal must be used to evaluate the calibrated white instead of using the internally generated test patterns.
- (Visual Trim)  + **Calibrated White** is not available if the display was calibrated using the SpectraView Engine (SVE). When using the SVE, test patterns always include any visual trim.

Reset/Restore panel

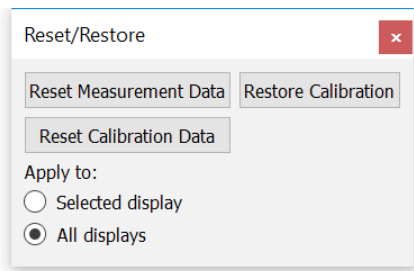

This panel is used to reset and restore measurements and settings.

Reset Measurement Data - Will clear all of the measurements taken during the Measurement phase of the calibration.

Reset Calibration Data - Will clear all of the calibration data including measurements and adjustment settings. It will not reset any settings in the displays.

Restore Calibration Settings - Will re-configure displays with the settings from the last calibration. This can be useful to switch between different calibrations by loading different projects and restoring the calibration data to all of the displays.

Since the calibration settings are stored as part of the Project files, entire wall calibrations can be restored by loading a Project file and using this function to restore the calibration settings to the displays.

These functions can be applied to the selected display or to all displays by selecting the appropriate setting in **Apply to:**

Note: Depending on the display model and calibration method, settings can be restored to different SpectraView Engine Picture Modes or to different Gamma Correction LUT locations. For more information, see:

- "Preferences dialog - Calibration Method panel" on page 62 for how calibration is performed and stored in each display.
- "Preferences dialog - SpectraView Engine" on page 66 when using SVE. See "SpectraView Engine (SVE)" in the "Supported Display Monitors" table on page 8 for models that support this feature.
- "Gamma Correction LUT" on page 64 when not using SVE.

Display Measurements panel

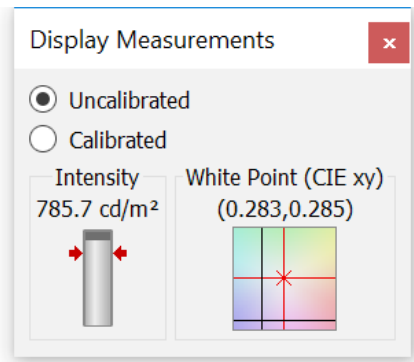

This panel shows the measured White Point values from the color sensor taken during the Measurement and Calibration operations. Both the White Point and Intensity (luminance) are shown as numerical values and graphically.

The **White Point** shows the measured value compared to the Target White Point in CIE xy.

This gives an indication as to the accuracy of the calibration compared to the Target value, as well as how far the display needed to be adjusted from the native state in order to achieve the Target White Point.

The **Intensity** bar shows the measured value. If the Target is a specific value, red arrows indicate this level on the bar.

Uncalibrated - Shows the native or un-calibrated measurement taken during the Measure operation.

Calibrated - Shows the corrected or calibrated measurement taken during the Calibration operation.

Calibration Target panel

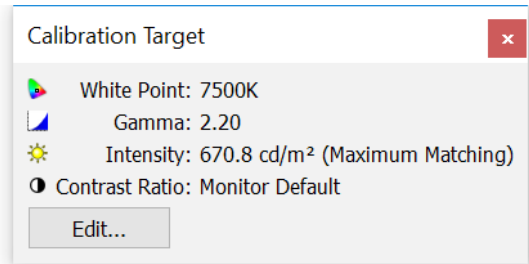

This panel shows the Calibration Target settings that will be used when the displays are calibrated.

The Calibration Target settings can be modified by clicking **Edit...** which will open the **Edit Calibration Target** dialog. See "Edit Calibration Target Configuration dialog" on page 56.

Tile Matrix Wizard dialog

The **Tile Matrix Wizard** dialog is accessed from the **Edit** menu, and is used to automatically configure the Tile Matrix settings on all or some of the displays in the current project. The Tile Matrix feature can be used to divide and expand video sources over multiple displays using internal processing in each display.

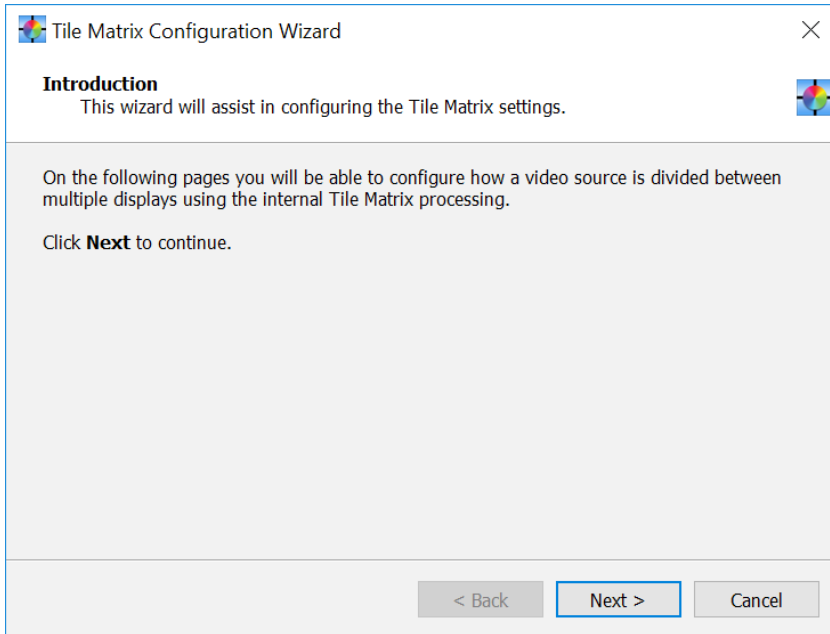

Tile Matrix Wizard Introduction.

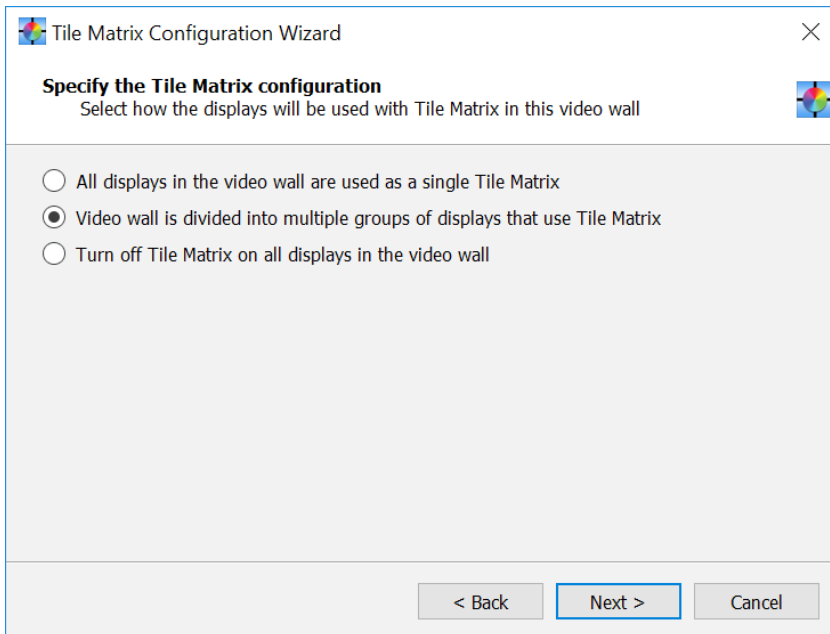

The Wizard can be used to enable a single tile matrix across all displays in the current project, or to configure multiple groups of displays within the project, or to disable Tile Matrix on all displays.

The Wizard will automatically calculate and configure the settings for the tile matrix horizontal and vertical sizes, and the matrix position for each display.

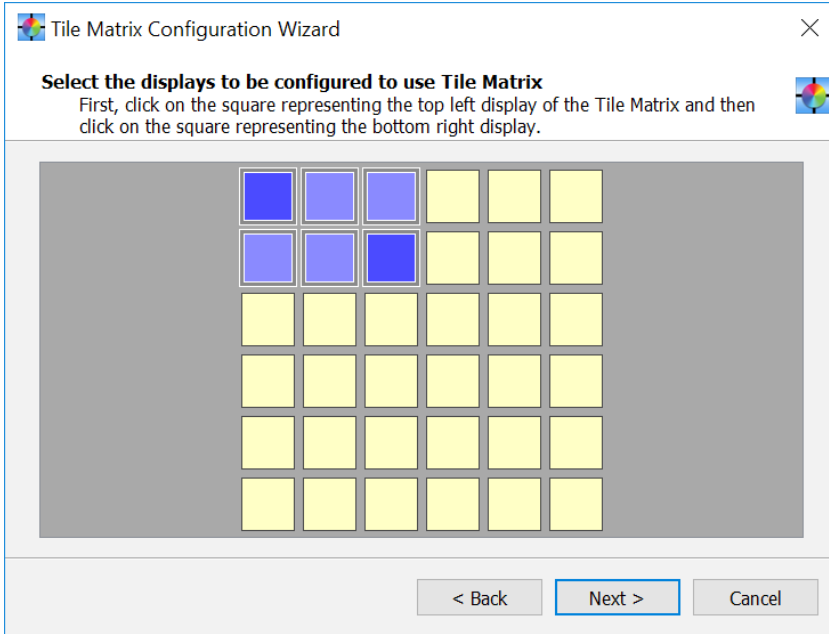

If the video wall is to be divided into multiple groups of displays, the displays in each group can be selected.

First, click on the square representing the top left display, and then click on the one representing the bottom right display.

Click **Next** to proceed to the next step.

Note: If a video wall larger than 10 rows or columns is used, the maximum size of a Tile Matrix selection will be 10 rows or columns.

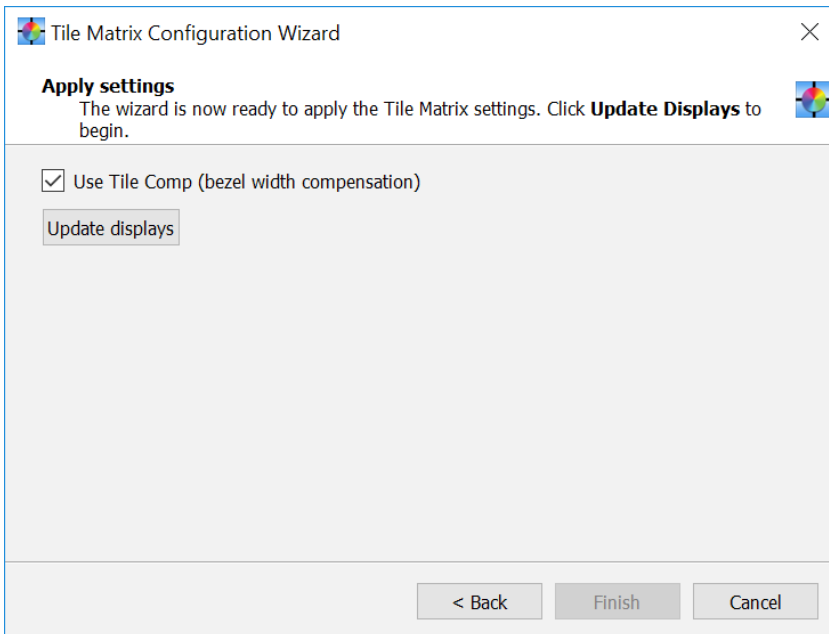

The Tile Matrix settings are sent to the displays on the final page of the Wizard by clicking the **Update Displays** button.

Selecting **Use Tile Comp** enables the Tile Comp feature, which compensates for the display bezel width when the video is divided across displays.

If more groups need to be configured, click the **Back** button and select the next group of displays. Repeat until all displays have been configured.

Calibration Target Offset

The **Calibration Target Offset** dialog is accessed from the **Edit** menu, and is used to configure the Target Offset for the selected display in the current project.

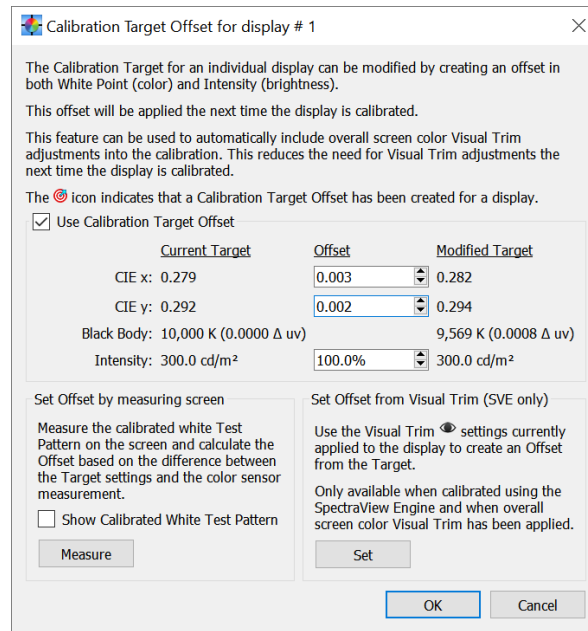

About “Calibration Target Offset”

During calibration, some displays may always need some manual “Visual Trim” adjustment to match the other displays in the video wall. This can be caused by uniformity, color sensor, or other factors. The Visual Trim adjustment can be saved as a Calibration Target Offset for the selected display. When the display is calibrated again, the Target and Offset is used for adjustment so that the additional Visual Trim step after calibration is no longer necessary.

This feature can also be used when a different white point or Intensity is desired or necessary on a display for a special purpose or application.

The Calibration Target Offset is specified in terms of the offset applied to the CIE x and y coordinates of the white point, as well as a percentage change to the Intensity (brightness).

The offset can be manually specified by entering values directly, or via the following methods:

Creating a Calibration Target Offset by measuring the calibrated display:

When using this method, the screen is measured then the offset is automatically calculated based on the difference in color and intensity between the measured value and the calibration Target.

1. Calibrate the video wall.
2. Perform any Visual Trim adjustments necessary.
3. For any displays that need Visual Trim, select the display and then select **Calibration Target Offset** from the **Edit** menu.
4. Select **Use Calibration Target Offset**.
5. Select **Show Calibrated White Test Pattern** (if not already selected).
6. Click **Measure** to measure the screen using the color sensor.
7. The difference between Target and Measured are automatically calculated (as CIE x, y and intensity %).

8. Click OK. The  icon should be shown in the main interface.

The next time the display is calibrated, the calibration process will use the modified Target.

Creating a Calibration Target Offset by from a Visual Trim overall color adjustment:

If the display has been calibrated using the SpectraView Engine and an overall screen color correction has been applied using the Visual Trim function, this adjustment can be converted into an offset to the current Target. If the display is calibrated again, the Visual Trim adjustment will now be applied in the form of a Calibration Target Offset.

1. Click the **Set** button to apply the Visual Trim overall color settings to the Calibration Target Offset.

The display will not need to be recalibrated.

2. Click **OK**. The  icon should be shown in the main interface and the Visual Trim overall color adjustment will be reset.

Display Settings dialog

The **Display Settings** dialog is accessed from the **Edit** menu and is divided into several different panels representing different functionality. Various settings on the displays can be set and read from this dialog. Settings can be applied to either an individual display, or to all of the displays in a particular row or column, or to all of the displays in the current project by selecting **Apply to:**

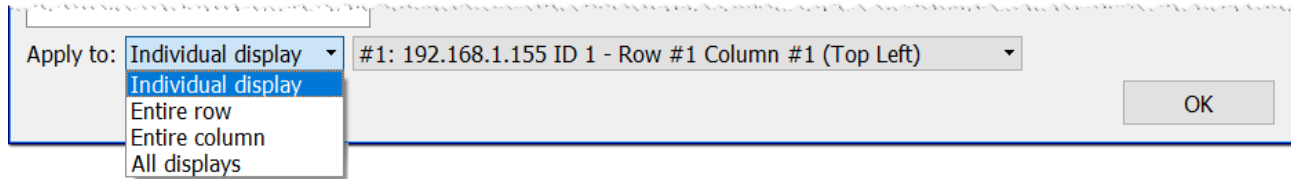

When multiple displays are selected by using the **Apply to:** selection with either **Entire Row**, **Entire Column**, or **All displays**, some controls will show an associated update button  used to update all of the selected displays with the relevant setting.

 **Note:** Not all controls will be available on all display models, display modes, or video inputs. Unavailable controls will be shown as disabled or return an error message.

Display Settings dialog - Power panel

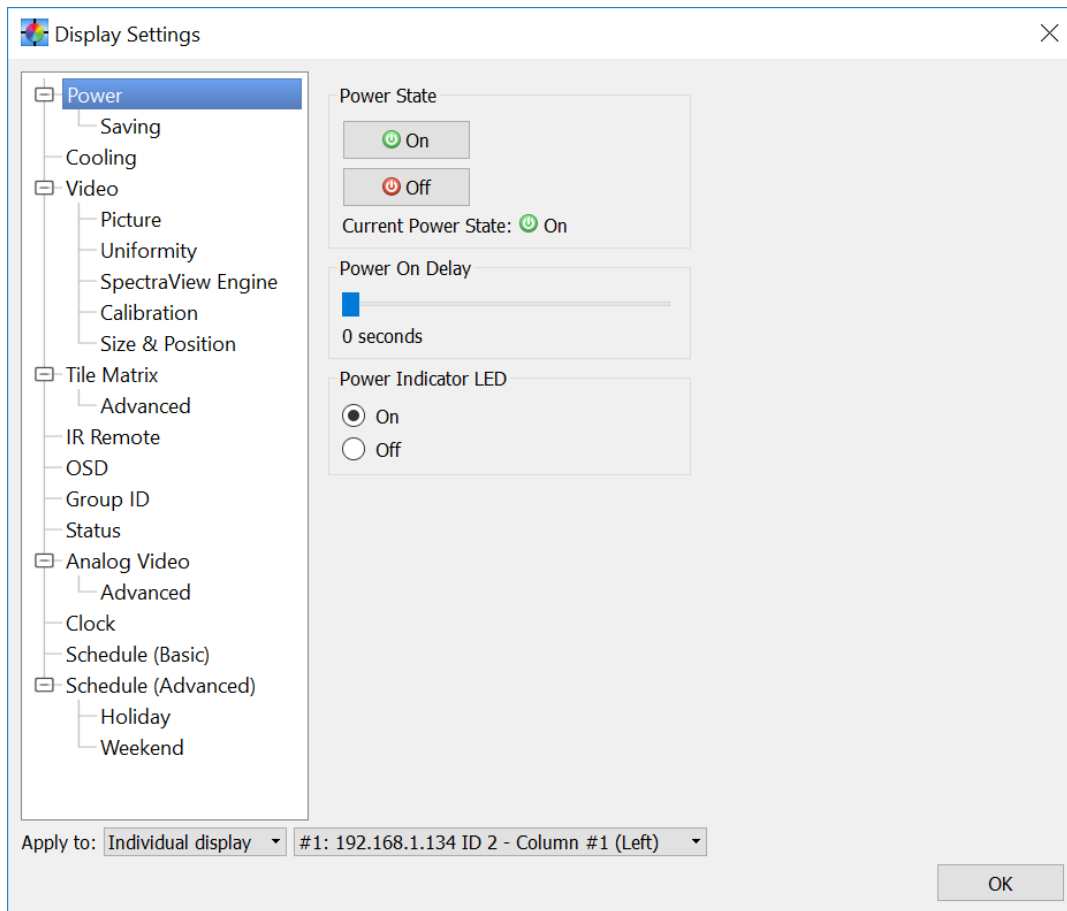

The **Power** panel controls the power settings of the displays.

Clicking the **On** button will turn the display or displays on. Clicking the **Off** button will turn the display or displays off.

The **Power On Delay** time can be adjusted for individual displays, or for all displays in the entire project. This control sets the time delay, in seconds, for the display to when the main display circuits are switched on after power on.

By staggering the delay time between displays, a sudden large power rush can be avoided when the video wall is turned on.

When **All Displays** is selected, the software will automatically calculate the staggered delay time for each display in the project according to the selected delay setting.

Power Indicator LED turns the power indicator LED on and off.

Display Settings dialog - Power panel - Saving settings

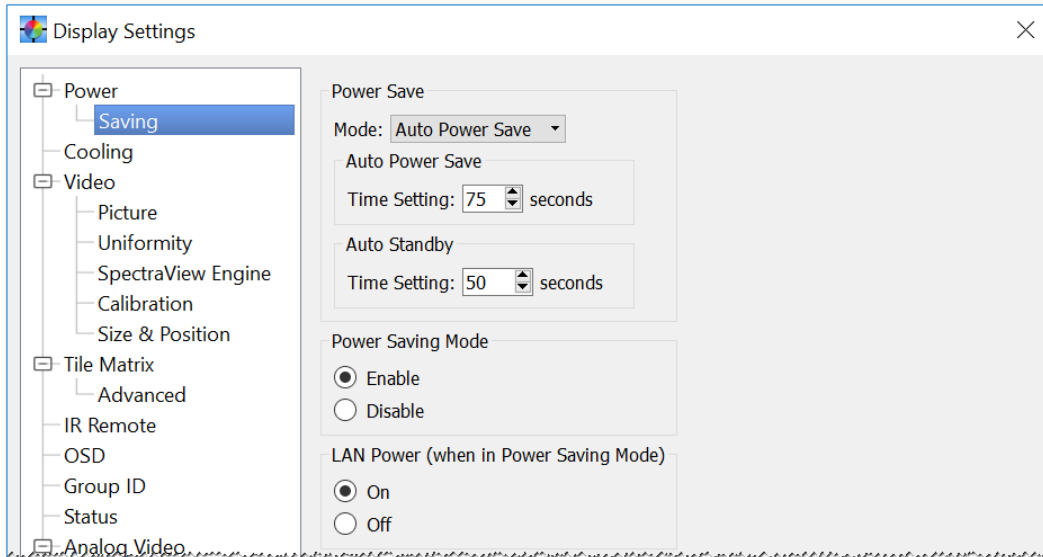

Power Saving settings can be set using either the **Power Save** or **Power Saving Mode** controls, depending on the display model being used.

The display will enter *Auto Power Save* or *Auto Standby* mode after the period of time set in **Time Setting** has passed with no signal input.

LAN Power sets the power setting for the display's LAN interface when the display is in a power saving mode. Setting to **Off** will save more energy, but the display will be unable to communicate and will not function as a 2-port LAN hub when in power saving mode. See "LAN Power setting" in the "Supported Display Monitors" table on page 8.

Display Settings dialog - Cooling panel

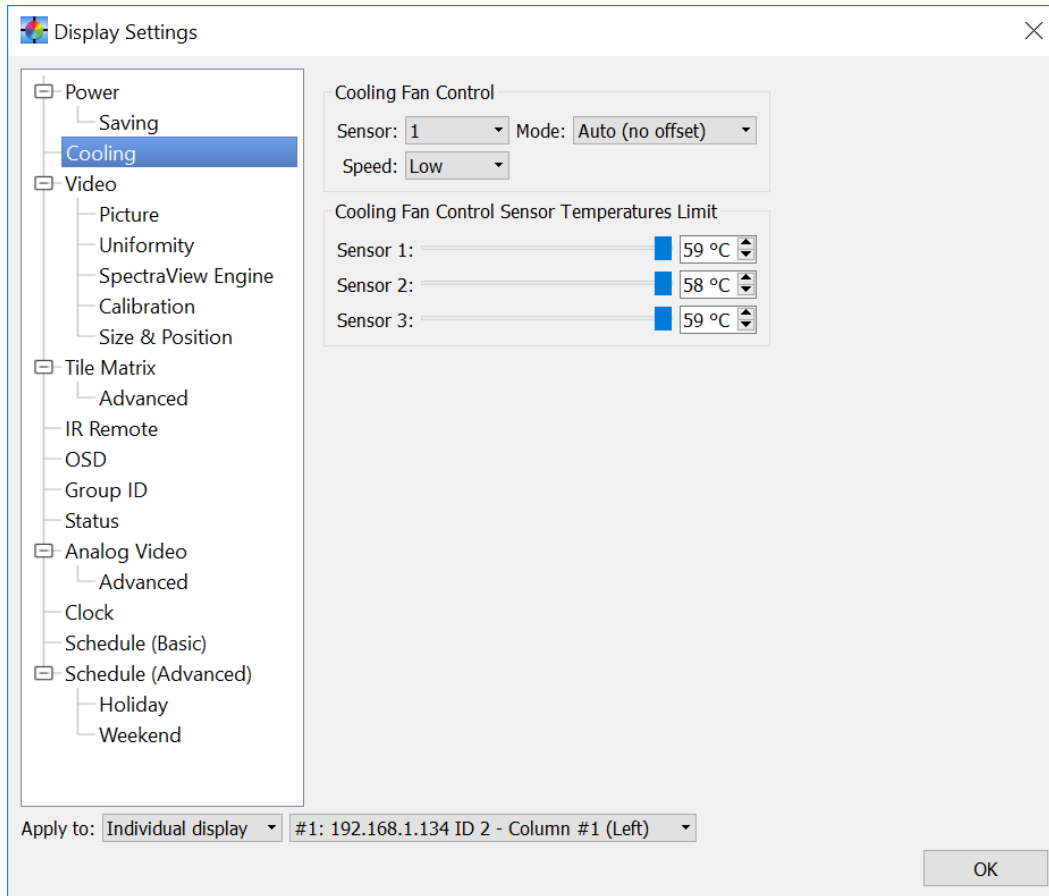

Cooling Fan Control adjusts the cooling fan settings such as fan speed, temperature trigger point, and forced on or automatic operation.

Cooling Fan Control Sensor Temperature Limits sets the specific temperature at which the cooling fans will start to operate.

Display Settings dialog - Video panel

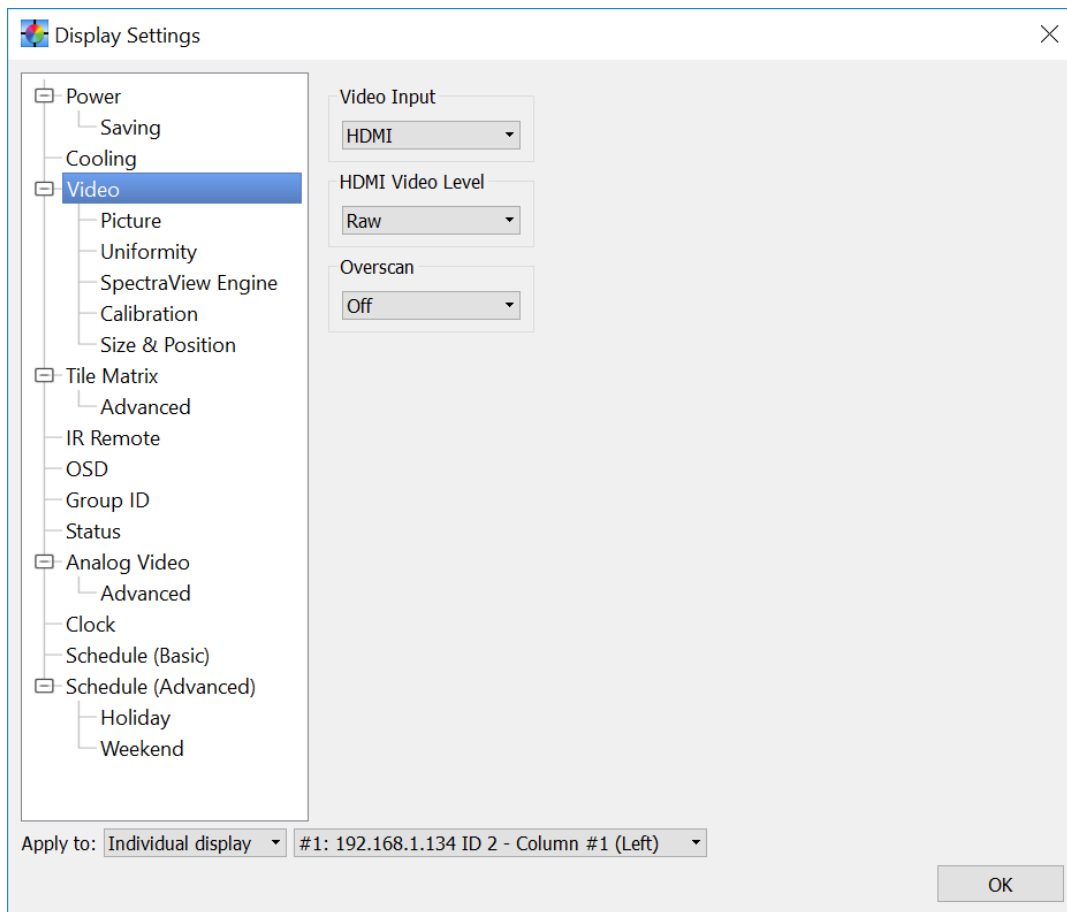

The **Video** panel is used to set the current video input and perform video signal and color adjustments.

The **Video Input** list shows the current video input being used by the display. The video input can be changed by selecting the desired input from the list.

Set the **HDMI Video Level** appropriate for the signal source:

RAW - Typically used for computer video sources. Shows all input signals levels from 0-255.

EXPAND - Typically used for audio-visual equipment sources that output reduced range video levels. Expands the input signals from 16-235 gray levels to 0-255 gray levels.

AUTO - Automatically sets input signals by adjusting connected equipment.

Select an **Overscan** option for how the image should be displayed:

On - When the image size is larger than what can be displayed, the image edges will be cropped and approximately 95% of the image will be shown on the screen.

Off - Image size stays within the display area and the whole image is displayed on the screen.

Auto - Image size is set automatically.

 **Note:** An **Update** button will appear next to each setting when multiple displays are selected for the **Apply to:** settings. The **Video** panel changes are not sent to the displays until the update button is clicked. Additionally, the **Video Input** list does not show the current video input. The video input is changed for the displays in the project by selecting the desired input from the list and clicking the **Update** button.

Display Settings dialog - Video panel - Picture settings

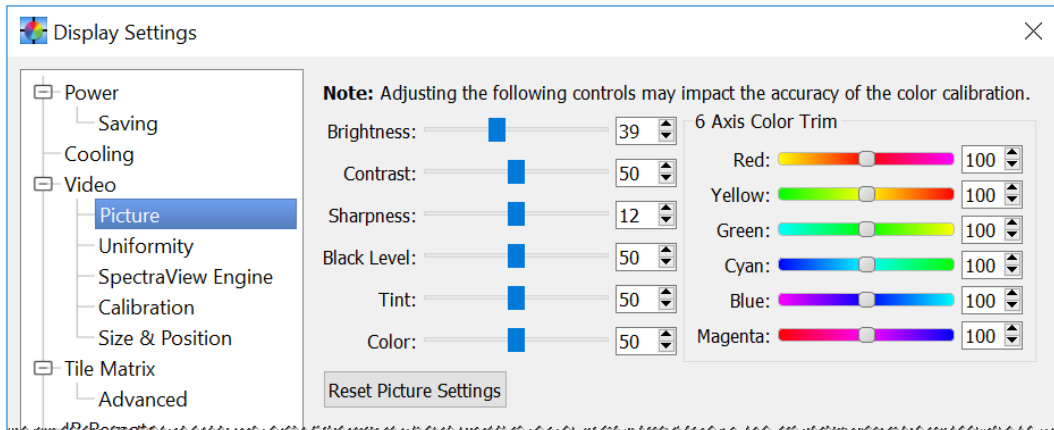

The **Brightness**, **Contrast**, **Sharpness**, **Black Level**, **Tint**, **Color**, and **6 Axis Color Trim** controls adjust the settings for the respective video controls in the display.

Important: Changing the settings for these controls may impact the color accuracy and matching of the video wall color calibration.

Display Settings dialog - Video panel - Uniformity settings

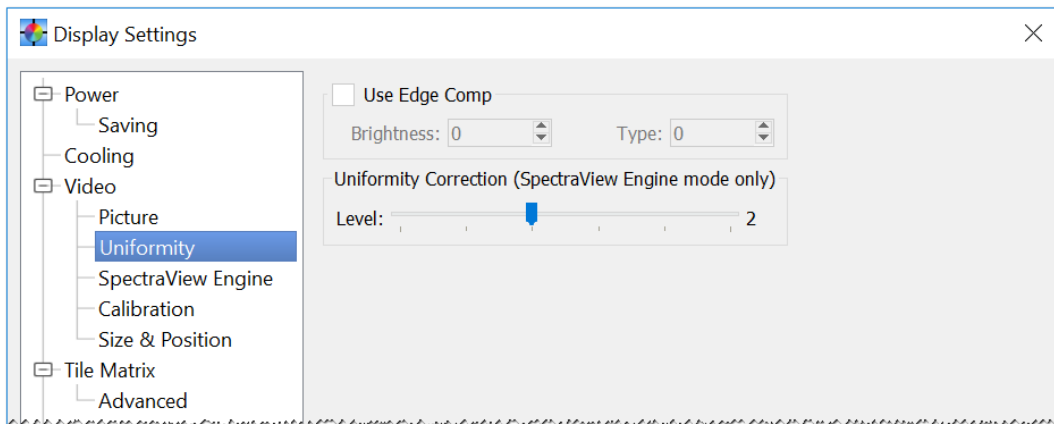

The **Use Edge Comp** controls adjust the edge mura compensation settings in the display (if supported).

The **Uniformity Correction (SpectraView Engine mode only)** adjusts the screen uniformity correction applied to the display to improve the screen luminance and color uniformity. A higher level of correction gives a more uniform screen. However, the maximum Intensity (brightness) that can be achieved is lower. This option is only used when using SVE with display models that support both SVE and Uniformity Correction. See "SpectraView Engine (SVE)" and "Uniformity Correction" in the "Supported Display Monitors" table on page 8 for models that support these features.

Display Settings dialog - Video panel - SpectraView Engine settings

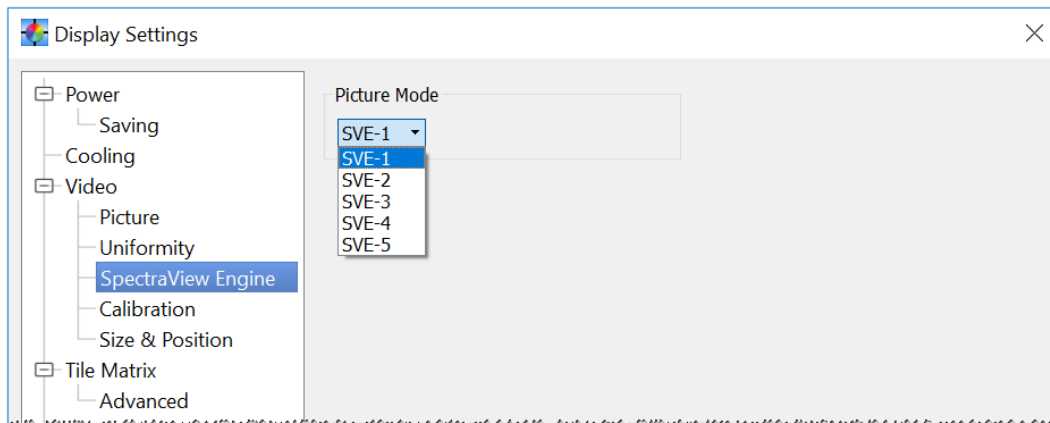

The SpectraView Engine panel is used to select which **Picture Mode** calibration to use. There are five different modes (memories) available and each can store a different calibration. This allows for quickly switching between different calibrations by changing the picture mode. See "SpectraView Engine (SVE)" in the "Supported Display Monitors" table on page 8 for models that support this feature.

Note: This setting only changes the current Picture Mode in the display and doesn't impact which Picture Mode is used for Calibration or Restore. See "Preferences dialog - SpectraView Engine" on page 66.

Display Settings dialog - Video panel - Calibration settings

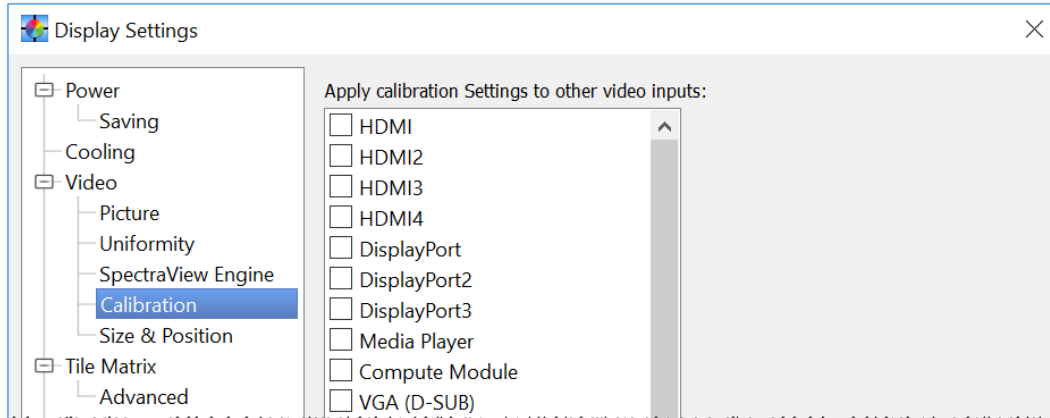

The **Calibration** panel is used to apply the various calibration settings to video inputs other than the input that was selected when the display was calibrated.

Each video input can have its own settings for various controls, such as Brightness, Gamma Selection, Picture Mode, etc.

During calibration, the settings for the currently selected video input are automatically configured. However, if at some point other types of video inputs will be used with the video wall, the settings for those inputs will need to be correctly configured to use the calibrated settings.

Select the video inputs to apply the calibrated settings to and click the **Apply** button.

Display Settings dialog - Video panel - Size & Position settings

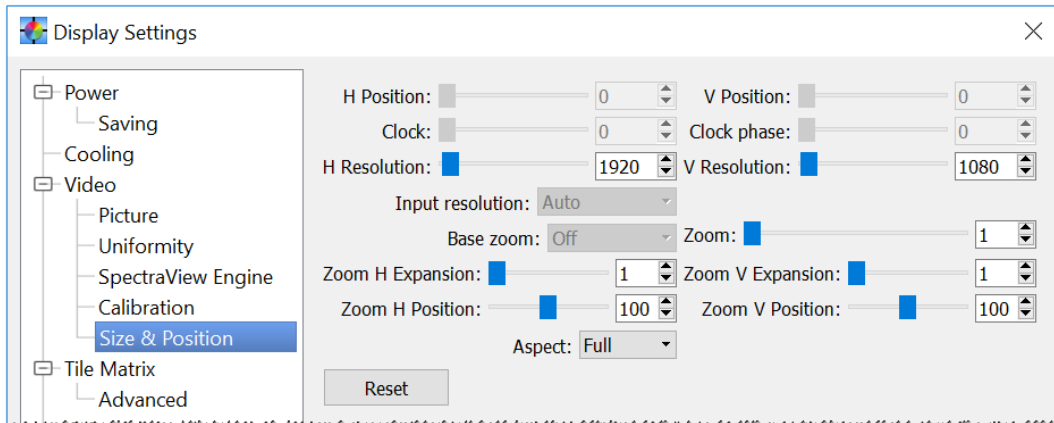

The **Size/Position** panel can be used to configure the various video size and position settings in the display. When **All Displays** is selected, controls are not updated until the associated update button  is clicked.

Display Settings dialog - Tile Matrix panel

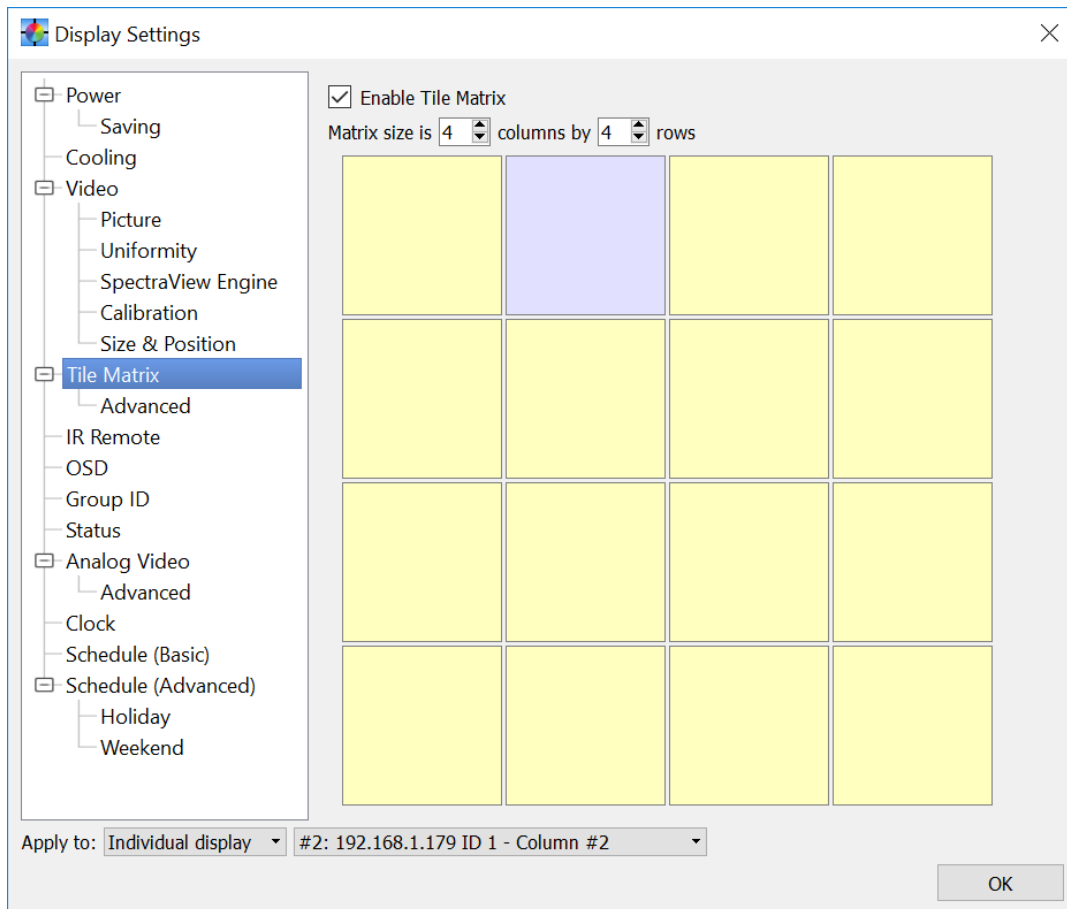

The **Tile Matrix** panel can be used to configure the Tile Matrix settings for dividing and expanding a video source over multiple displays.

Enable Tile Matrix - Is used to enable the Tile Matrix feature in each display.

Matrix size - Is used to set the matrix size in rows and columns.

When a single display is selected, the position in the tile matrix can be selected by clicking the relevant display on the matrix diagram.

 **Note:** The **Tile Matrix Wizard** can be used to automatically configure the Tile Matrix settings for all displays in the project.

Display Settings dialog - Tile Matrix panel - Advanced settings

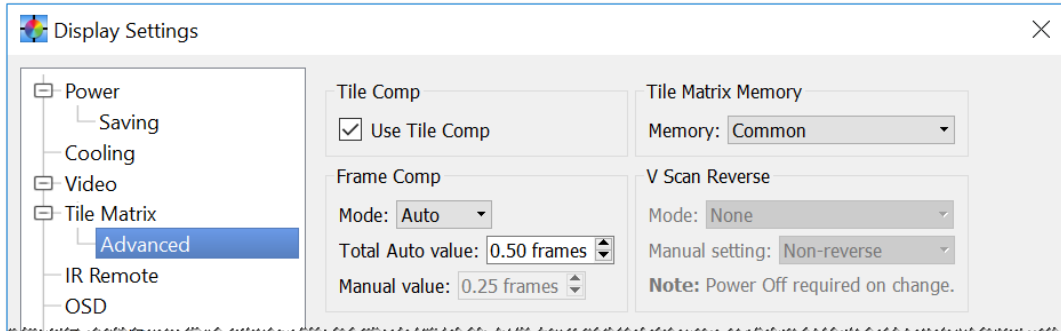

Tile Comp - Scales the displayed image to compensate for the width of the screen bezel in order to create a seamless image.

Tile Matrix Memory - Applies the Tile Matrix settings to all video inputs (Common) or to the current input only (Input).

Frame Comp (panel scanning compensation) - Adds a delay to the displayed video in order to reduce frame gaps between tiled rows when showing moving images. See the Tooltip help for this control for additional information.

V Scan Reverse (panel vertical scan direction) - Normally, panels are scanned from top to bottom. Reversing direction on alternate rows of tiled displays can reduce frame gaps between rows when showing moving images. See the Tooltip help for this control for additional information.

Display Settings dialog - IR Remote panel

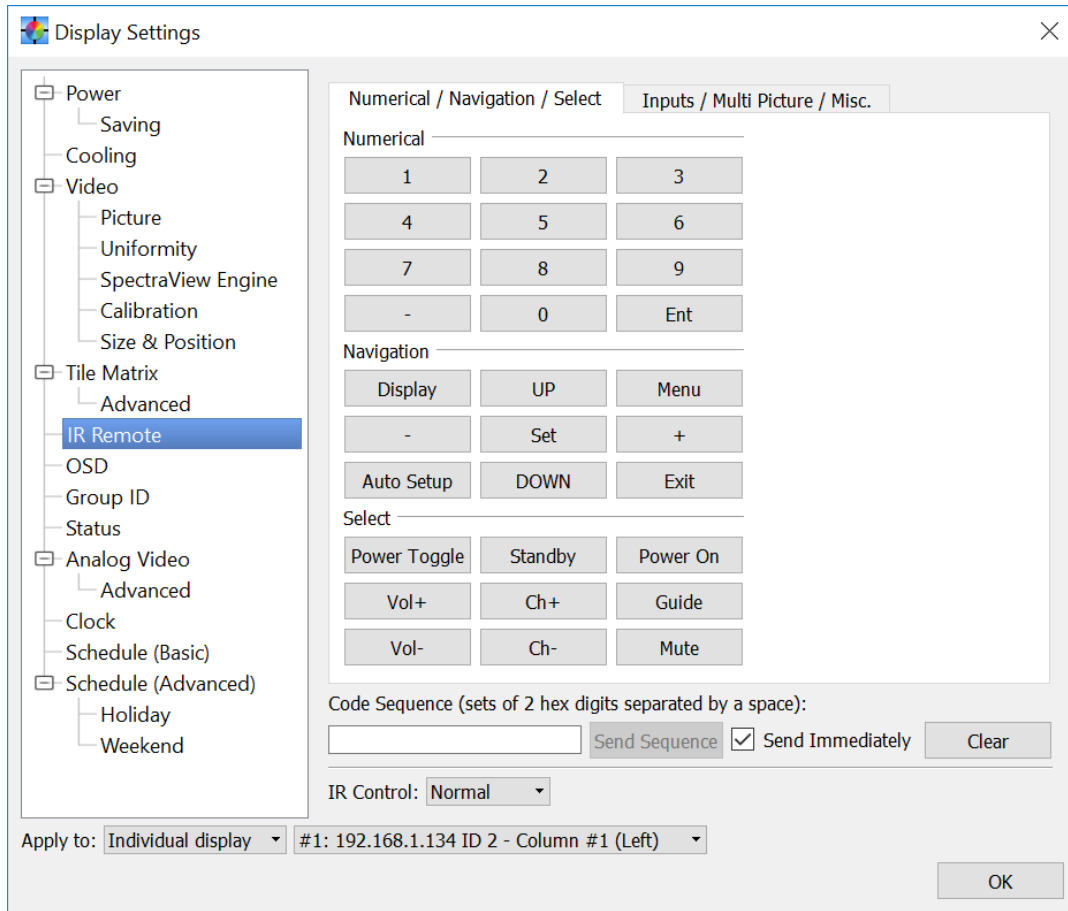

The **IR Remote** panel can be used to perform the equivalent operations as the physical IR Remote control, using the software and communicating using the LAN or RS232 connection to the display.

This is useful when it is not practical to use the actual IR Remote control with the display, or when it is necessary to access controls by remote that are not available from within the software.

The remote commands are on two tabs in the IR Remote panel: **Numerical / Navigation / Select** and **Inputs / Multi Picture / Misc.**

Numerical / Navigation / Select

Numerical		
1	2	3
4	5	6
7	8	9
-	0	Ent
Navigation		
Display	UP	Menu
-	Set	+
Auto Setup	DOWN	Exit
Select		
Power Toggle	Standby	Power On
Vol+	Ch+	Guide
Vol-	Ch-	Mute

Inputs / Multi Picture / Misc.

Inputs			
DVI	DisplayPort	VGA	Y/Pb/Pr
HDMI	DVD/HD	Video	RGB/HV
S-Video	Option	DVI1	DVI2
HDMI1	HDMI2	HDMI3	HDMI4
Media Player	Compute Module		
Multi Picture			
Picture Mode	Sound	Audio Input	Option Menu
Wait 1s	Image Flip	Aspect	Active Picture
Preset 1	Preset 2	Preset 3	
Misc.			
On/Off	Mode	Change	
Aspect	Rotate	Rotate All	

Select the display to control from the **Apply To Display** list. Click the buttons to send the IR Remote command to the display. The display will respond as if it received a signal from the IR Remote control.

- Sequences of commands can be created and sent to the display at once by clicking the **Send Sequence** button.
The IR Remote command code will appear in the Code Sequence list and can be manually edited. Each IR Remote button is a single 2 hex digit code.
- To prevent each IR Remote command code from being sent to the display as each button is pressed, **deselect the Send Immediately checkbox.**

IR Control selects the mode for using the infra-red remote control to control multiple displays when using an RS232 daisy chain between displays.

- When **Normal** is selected, the monitor will be controlled normally by IR remote controller.
- Select **Primary** on the first display in an RS232 daisy chain configuration to use it as the IR Receiver for all of the displays. Select all of the other displays on the daisy chain to **Secondary**. The Primary display will forward IR commands received from the sensor to the other displays via RS232.
- Select **Lock** to prevent operation of the IR remote receiver.

Display Settings dialog - OSD panel

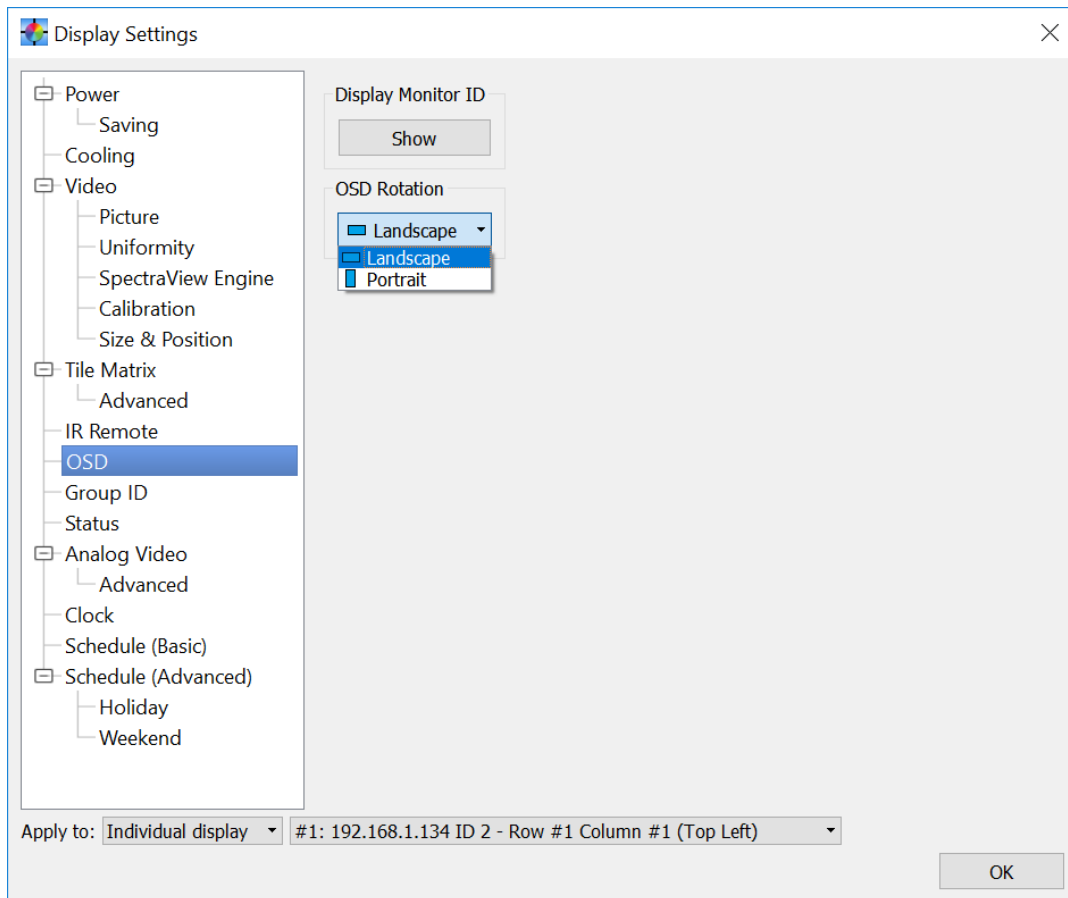

The **OSD** panel can be used to show the display's monitor ID and rotate the OSD menu.

Select **Show** under Display Monitor ID to briefly show the display's Monitor ID on screen (supported models only). When **Apply to: All displays** is selected, all monitor's will briefly display their ID.

Select **Portrait** or **Landscape** to rotate the OSD menu to match the orientation of the monitor installation.

Display Settings dialog - Group ID panel

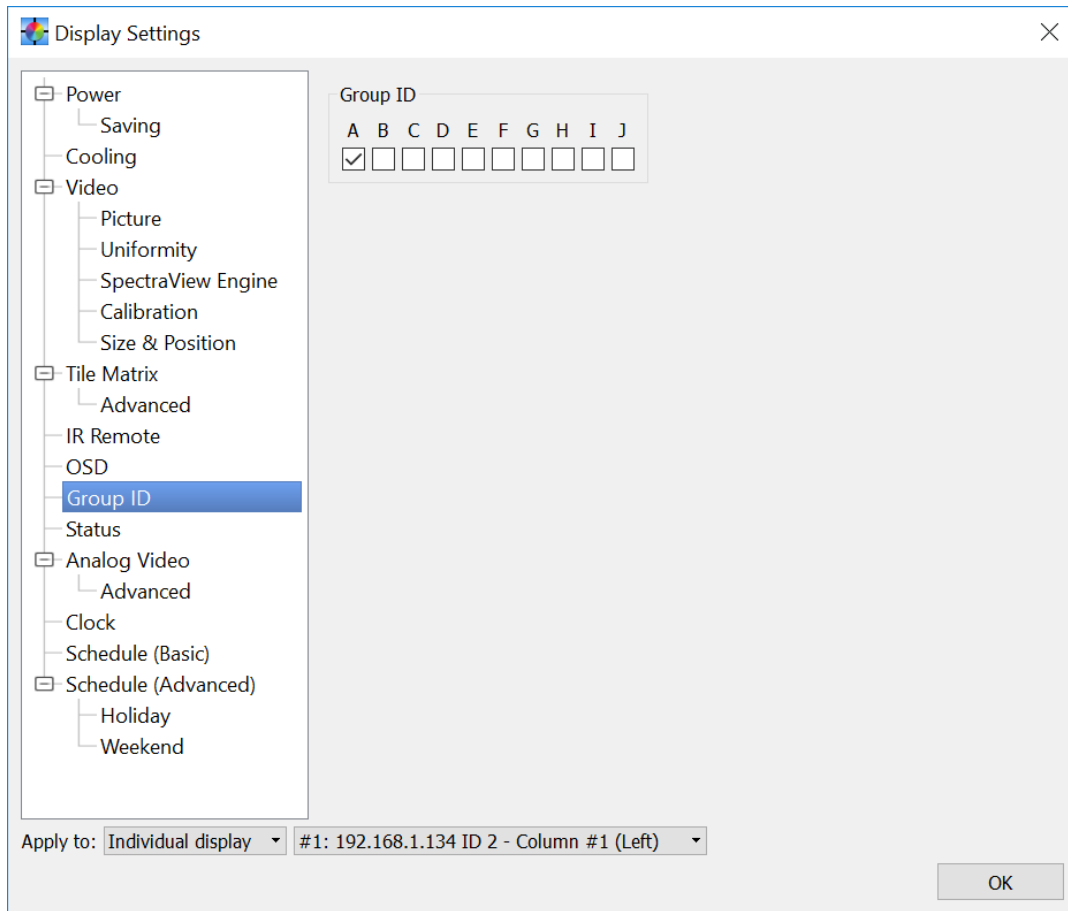

The **Group ID** panel is used to assign the selected monitor(s) to different addressable logical groups. Group IDs can be used to address multiple displays via control commands addressed to individual groups. *NEC Display Wall Calibrator* does not use the Group ID but other applications can make use of this functionality.

Display Settings dialog - Status panel

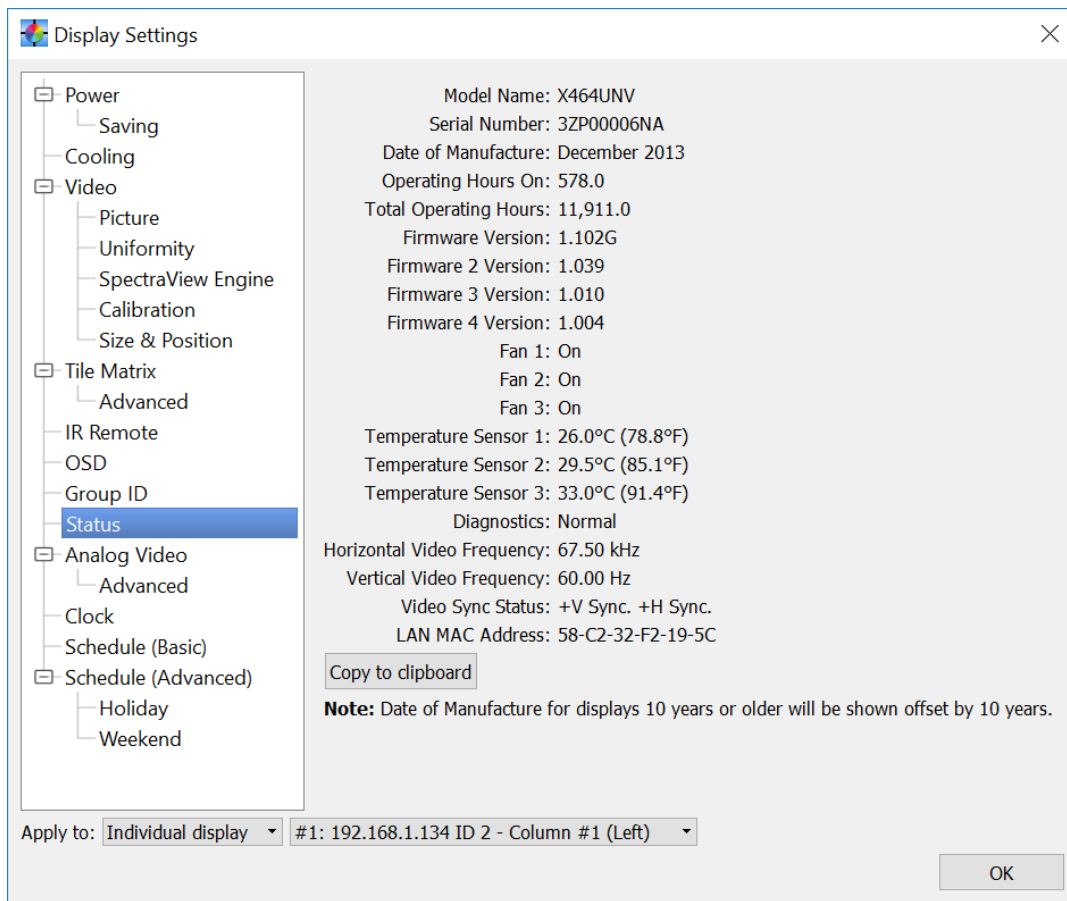

The **Status** panel reports various aspects about the currently selected display. This feature is not available when **All Displays** is selected.

Date of Manufacture - Shows the monitor's date of manufacture based on the serial number. Due to the serial number encoding scheme, monitors older than 10 years will be shown offset by 10 years.

Operating Hours - Shows the number of hours that the currently selected display has been in operation.

Firmware Version and **Firmware 2, 3, and 4 Version** - Shows the version number(s) of the firmware in the display. Firmware 2, 3, and 4 Version is not available on all models.

Fan 1, 2, and 3 - Shows the current operating status of the internal cooling fans of the display. On, Off and Error conditions are reported. The fan settings can be adjusted on the **Cooling** panel.

Temperature Sensor 1, 2, and 3 - Shows the current internal temperature sensor readings of the display.

Diagnostics - Shows the diagnostic condition reported by the display, as well as various failure conditions such as power supply, fan, and temperature abnormalities.

Horizontal, Vertical Video Frequency, Video Sync - Shows the video frequency and sync polarity of the current video input.

LAN MAC Address - Shows the LAN MAC address of the display monitor.

Display Settings dialog - Analog Video panel

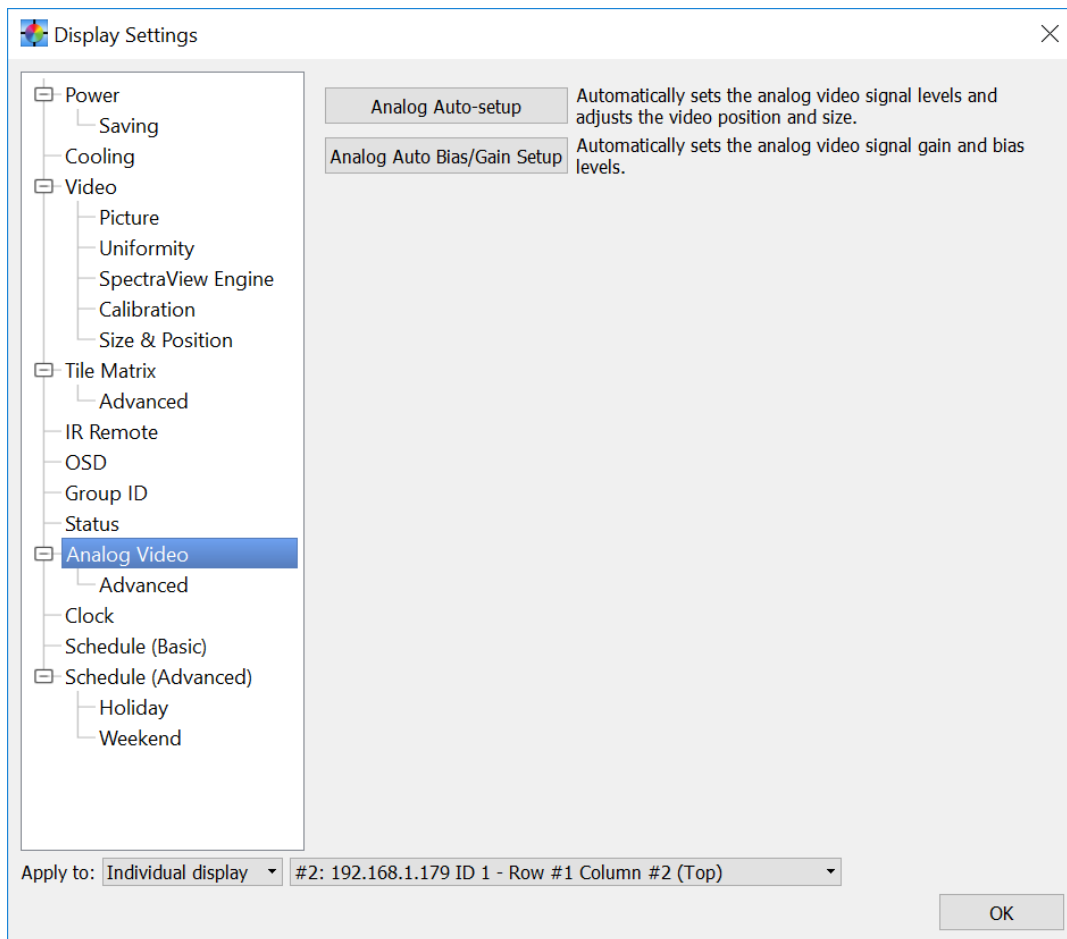

The **Analog Video** panel can be used to set special video adjustment patterns to assist with manual adjustment of the analog video input levels.

The following two controls are only available when analog video inputs such as VGA, RGB/HV, and Option-Analog. It is not necessary to re-calibrate the displays after performing these operations.

Analog Auto-Setup will measure the incoming analog video signal and automatically set the video level controls in the display, as well as the size and position of the video.

This operation should only be performed when a new analog video signal is connected, when a major change is made to the video wiring to the display, or when a video amplifier or splitter is added to the video link.

Note: It is essential that when this operation is performed, a video signal that contains both pure black and pure white is being input. White video should extend to each edge of the active video area, otherwise the controls may not be adjusted correctly by the display. A sample test pattern is installed with the software and should be displayed full-screen on the video source input.

Analog Auto Bias/Gain Setup will measure the incoming analog video signal and automatically set the video level bias and gain controls in the display.

This operation should be performed if there is a color tint on black video after the display has been calibrated.

Note: It is essential that when this operation is performed a color bar test pattern video signal is input, otherwise the controls may not be adjusted correctly by the display. A sample test pattern is installed with the software and should be displayed full-screen on the video source input.

Display Settings dialog - Analog Video panel - Advanced settings

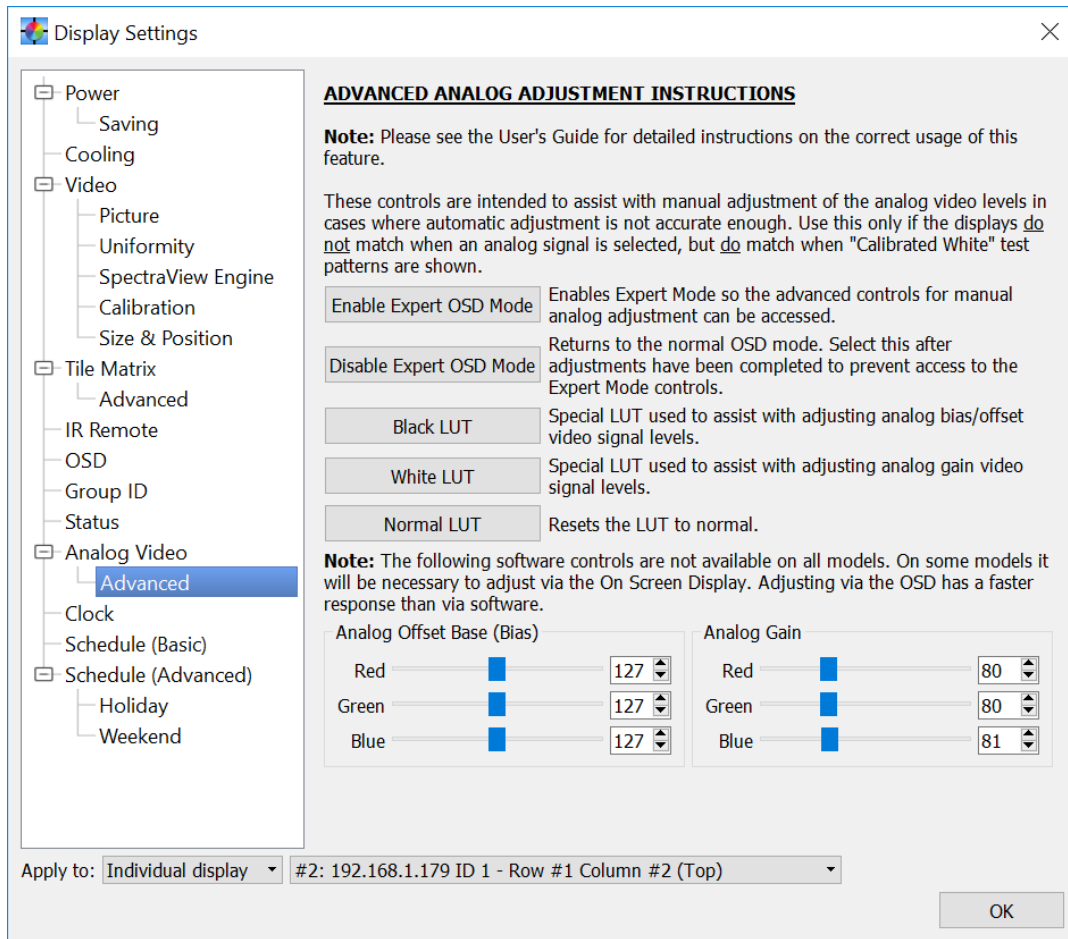

This advanced feature should only be used in cases where:

- The Calibrated White test patterns match satisfactorily, but a white analog video signal input does not. If the Calibrated White test patterns do not match, either re-calibrate or use the **Visual Trim** function to manually adjust each display slightly.
- The automatic **Analog Auto Bias/Gain Setup** control is not able to provide an accurate enough adjustment of the analog video signal.

See Chapter 12 "Advanced Analog Adjustment function" on page 125 for a detailed step by step guide on how to use this function.

Display Settings dialog - Clock panel

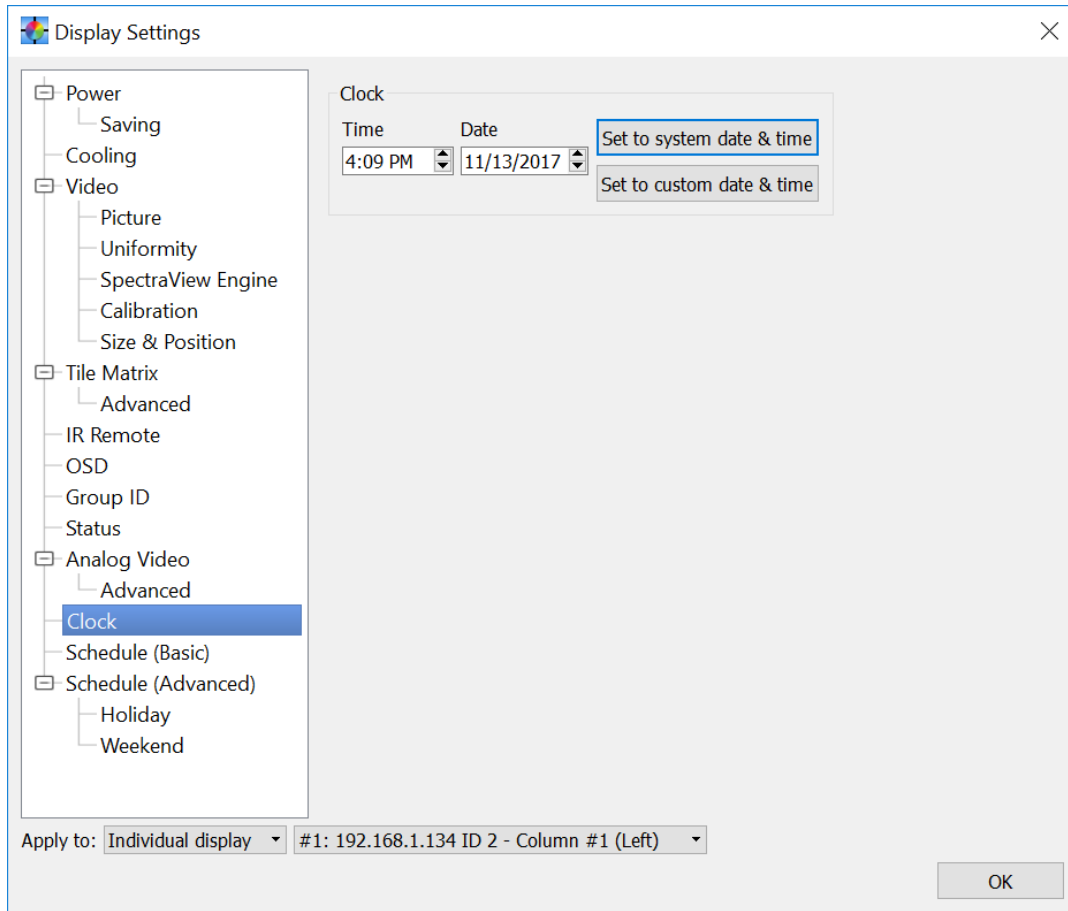

The **Clock** panel is used to set the internal real time clock and schedule functions in the display. Various scheduled operations such as power on, power off, and changing inputs can be configured.

The internal clock can be set to the host PC's system date and time by clicking the **Set to system date & time** button.

When **Display** is selected, a custom time and date can be set in the display by modifying the **Time** and **Date** fields and clicking the **Set to custom date & time** button.

When a single display is selected using **Display**, the current time and date of the clock in the display is shown.

Display Settings dialog - Schedule (Basic) panel

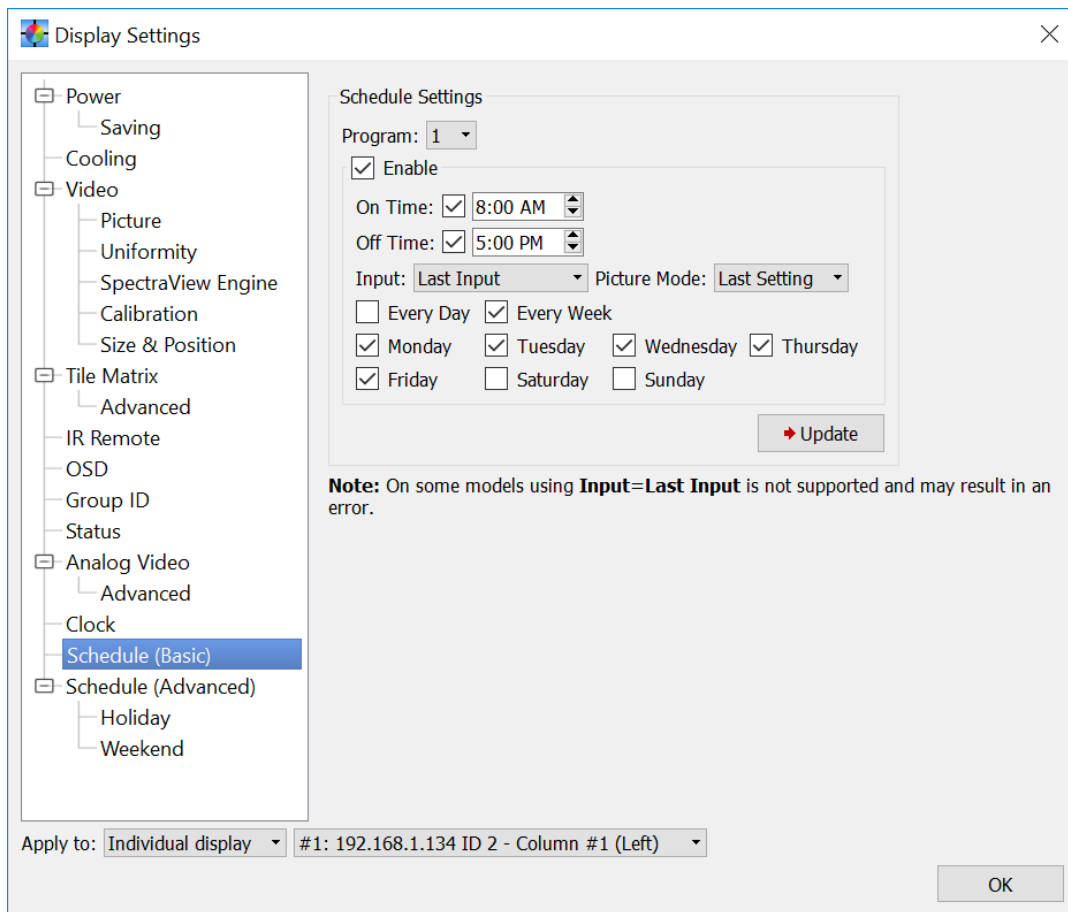

The **Schedule (Basic)** panel is used to set the schedule function in the display. Various scheduled operations such as power on, power off, and changing inputs can be configured.

Seven different schedules can be configured and selected from the **Program** listbox. Each schedule can be enabled or disabled by selecting **Enable**. On and Off times can be specified and enabled or disabled, as well the video **Input** and **Picture Mode** (if supported by the display). Settings are updated by clicking the **Update** button.

If an error message shows on this panel that there is an unsupported command or incorrect Monitor ID, the selected display may have advanced scheduling features such as defining holiday and weekend days. In this case, use the **Schedule (Advanced)** panel to control the scheduling function in the display.

Display Settings dialog - Schedule (Advanced) panel

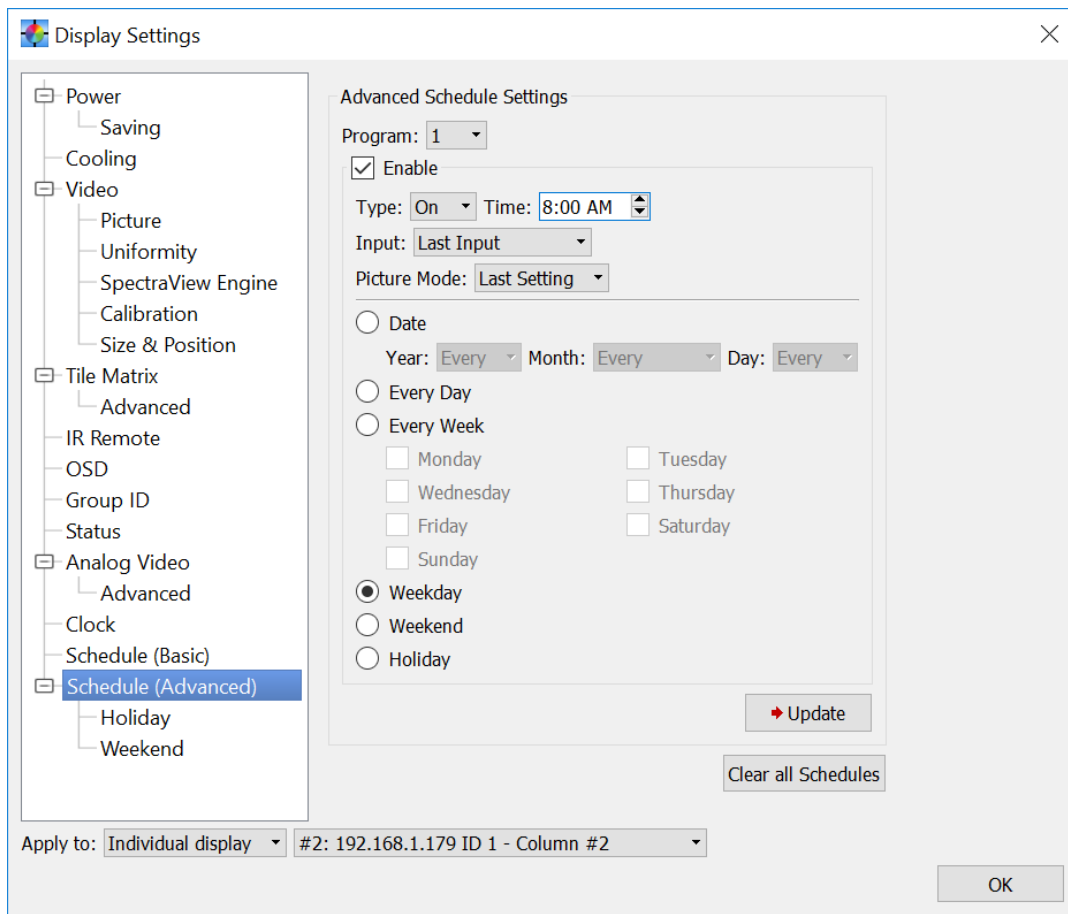

The **Schedule (Advanced)** panel is used to set the schedule function in the display. Various scheduled operations such as power on, power off, and changing inputs can be configured.

Up to 30 different schedules can be configured and selected from the **Program** listbox. Each schedule can be enabled or disabled by selecting **Enable**. On and Off times can be specified and enabled or disabled, as well the video **Input** and **Picture Mode**. Settings for each Program are updated by clicking the **Update** button.

If an error message shows on this panel that there is an unsupported command or incorrect Monitor ID, the selected display may not support the advanced scheduling features that are on this panel. In this case, use the **Schedule (Basic)** panel to control the scheduling function in the display.

Display Settings dialog - Schedule (Advanced) panel - Holiday settings

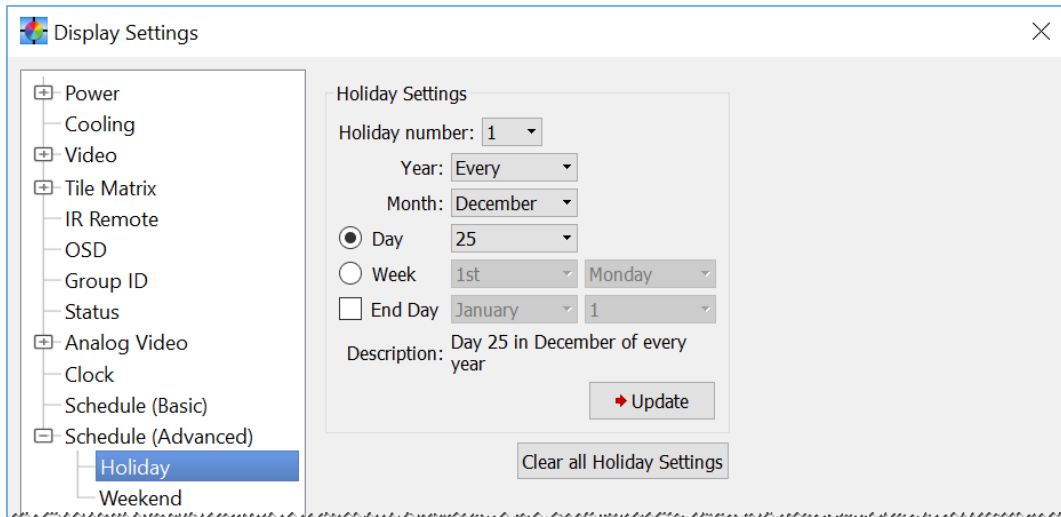

The **Holiday** panel is used to define which days are holidays for the display schedule. When the selected program on the **Schedule (Advanced)** panel has "Holiday" selected, the dates defined in this panel are when the schedule runs.

Display Settings dialog - Schedule (Advanced) panel - Weekend settings

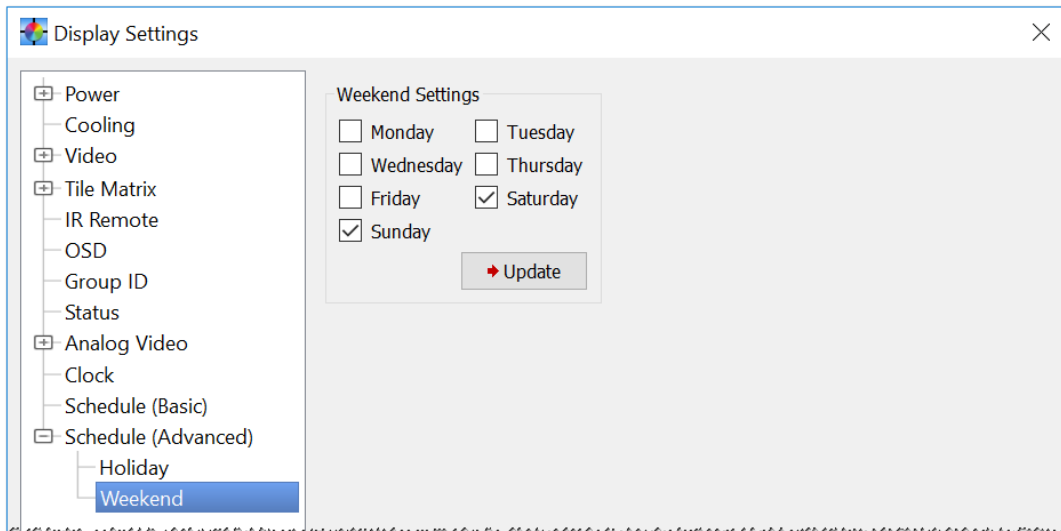

The **Weekend** panel is used to define which days are weekend days for the display schedule. When the program on the **Schedule (Advanced)** panel has "Weekend" selected, the days of the week selected here is when the schedule runs. If the program on the **Schedule (Advanced)** panel has "Weekday" selected, the schedule is not run on these days.

Summary window

The **Summary** window is accessed from the **View** menu. See "View menu" on page 103.

This window shows the current layout configuration and connections, as well as detailed information about the calibration results.

The screenshot shows the Summary window with two main sections: Connection Summary and Calibration Summary.

Connection Summary:

Port	Monitor ID	Model	Serial Number	Firmware Version	MAC Address	Orientation	SpectraView Engine	Corner Uniformity	Update Uniformity	Update Factory Color Calibration	Status
1 192.168.0.1	1	UN5515	6X000278NA		8C-DF-9D-73-EE-63	Landscape	Unsupported	Unsupported	Unsupported	Unsupported	Calibrated
2 192.168.0.2	2	UN5515	6X000285NA		8C-DF-9D-73-EE-68	Landscape	Unsupported	Unsupported	Unsupported	Unsupported	Calibrated
3 192.168.0.3	3	UN5515	71000775NA		74-3A-65-A0-83-41	Landscape	Unsupported	Unsupported	Unsupported	Unsupported	Calibrated
4 192.168.0.4	4	UN5515	6X000352NA		8C-DF-9D-73-EE-80	Landscape	Unsupported	Unsupported	Unsupported	Unsupported	Calibrated
5 192.168.0.5	5	UN5515	71000684NA		74-3A-65-A0-82-DF	Landscape	Unsupported	Unsupported	Unsupported	Unsupported	Calibrated
6 192.168.0.6	6	UN5515	6X000341NA		8C-DF-9D-73-EE-A5	Landscape	Unsupported	Unsupported	Unsupported	Unsupported	Calibrated
7 192.168.0.7	7	UN5515	6X000342NA		8C-DF-9D-73-EE-A4	Landscape	Unsupported	Unsupported	Unsupported	Unsupported	Calibrated

Calibration Summary:

Uncalibrated Intensity	Uncalibrated White Point (CIE xy)	Uncalibrated Contrast Ratio	Maximum Calibrated Intensity	Date Measured	Operating Hours when Measured	Actual Calibrated Intensity	Actual Calibrated White Point (CIE xy)	Date Calibrated	Operating Hours when Calibrated	Calibrated Brightness Setting	Calibrated Color Settings	Uniformity Settings
1 787.7 cd/m ²	9.351 K (0.282,0.298)	46,806:1	748.3 cd/m ²	10/30/2017 8:39 PM	116.5	652.2 cd/m ²	10.034 K (0.279, 0.292)	10/30/2017 8:51 PM	116.5	87.0%	LUT R=252, G=250, B=255	Not supported
2 763.7 cd/m ²	10.477 K (0.276,0.288)	8,971,547:1	751.1 cd/m ²	10/30/2017 8:40 PM	117.0	647.0 cd/m ²	10.047 K (0.279, 0.292)	10/30/2017 8:56 PM	117.5	84.0%	LUT R=255, G=254, B=251	Not supported
3 711.3 cd/m ²	9.478 K (0.283,0.294)		694.2 cd/m ²	10/30/2017 8:40 PM	75.0	653.5 cd/m ²	10.113 K (0.278, 0.291)	10/30/2017 9:01 PM	75.5	93.0%	LUT R=247, G=253, B=254	Not supported

Connection Summary:

Port - Shows the Communications Port to the display, either the RS232 COM Port or LAN IP Address.

Monitor ID - Shows the Monitor ID used to identify the display monitor.

Model - Shows the model of the display monitor.

Serial Number - Shows the serial number of the display monitor.

Firmware Version - Shows the version of the internal firmware of the display monitor.

MAC Address - Shows the LAN MAC address of the display monitor.

Orientation - Shows the current screen orientation (Portrait or Landscape). The orientation setting is used to set the correct OSD rotation, as well as other orientation relevant settings such as Corner Uniformity Correction. The orientation can be changed from the context menu in the Main window. See "Main window context menu" on page 55.

SpectraView Engine - Indicates if the display supports the SpectraView Engine.

Corner Uniformity - Indicates if the display supports the Color Uniformity Correction feature. See Chapter 8 "Visual Trim function" on page 113.

Update Uniformity - Indicates if the display supports the Update Uniformity Correction feature. See Chapter 9 "Update Uniformity" on page 118.

Update Factory Color Calibration - Indicates if the display supports the Update Factory Color Calibration feature. See Chapter 10 "Update Factory Color Calibration" on page 121.

Status - Shows the current status of the display monitor in the measurement and calibration process.

Calibration Summary:

Uncalibrated Intensity – Shows the measured native Intensity (luminance) of the display when un-calibrated.

Uncalibrated White Point – Shows the native white point of the display when un-calibrated.

Uncalibrated Contrast Ratio – Shows the native contrast ratio of the display when un-calibrated.

Maximum Calibrated Intensity – Shows the calculated maximum Intensity that can be achieved by the display using the current Target White Point setting. If the current Target Intensity method is set to Specific Level and the calculated value is more than 5% lower than the Target, then a yellow warning icon is shown to warn that the displays may not match in Intensity after calibration using the current Specific Level value, and a lower value should be chosen.

Date Measured – Shows the date and time that the un-calibrated measurements were taken.

Operating Hours when Measured – Shows the number of hours the display has been in operation at the time the un-calibrated measurements were taken.

Actual Calibrated Intensity – Shows the Intensity (luminance) of the display after it has been calibrated. If the current Target is set to Maximum Possible Matching or Specific Level, and the value is not within 10% of the Target Intensity value, then a yellow alert icon is shown to warn that the display could not achieve the desired Target Intensity value when calibrated.

Actual Calibrated White Point – Shows the white point that the display was adjusted to after calibration.

Date Calibrated - Shows the date and time when the calibration was performed.

Operating Hours when Calibrated – Shows the number of hours the display has been in operation when the calibration was performed.

Calibrated Brightness Setting – Shows the OSD Brightness setting value that the display was adjusted to when the calibration was performed.

Calibrated Color Settings – Shows information about the various color settings that were adjusted for the display during calibration.

Uniformity Settings – Shows information about the various screen uniformity correction settings being applied. See Chapter 8 "Visual Trim function" on page 113.

Print button - Prints the contents of the Summary window to a printer. This will open a Print Preview window. The font used can be changed by clicking the Set Font  button from within the Print Preview window (Windows version only).

Save as PDF button - Saves the contents of the Summary window to a PDF file. The font used can be changed by clicking the Set Font button from within the Print Preview window (Windows version only).

Print Preview

61.3%

1 / 2

Project file name: Acme Widgets Inc. - Main Lobby North.ndwc

Display Physical Layout:

#1 ID 1	#5 ID 5	#7 ID 7
#2 ID 2	#6 ID 6	#8 ID 8
#3 ID 3	#4 ID 4	#9 ID 9

Connection Summary:

Display #	Port	Monitor ID	Model	Serial Number	Firmware Version	MAC Address	Orientation	SpectraView Engine	Corner Uniformity	Update Uniformity	Update Factory Color Calibration	Status
1	192.168.0.1	1	UN651S	6X.000278NA		8C-DF-9D-73-EE-05	Landscape	Unsupported	Unsupported	Unsupported	Unsupported	Calibrated
2	192.168.0.2	2	UN651S	6X.000285NA		8C-DF-9D-73-EE-06	Landscape	Unsupported	Unsupported	Unsupported	Unsupported	Calibrated
3	192.168.0.3	3	UN651S	71000779NA		74-3A-65-A0-83-41	Landscape	Unsupported	Unsupported	Unsupported	Unsupported	Calibrated
4	192.168.0.4	4	UN651S	6X.000352NA		8C-DF-9D-73-EE-09	Landscape	Unsupported	Unsupported	Unsupported	Unsupported	Calibrated
5	192.168.0.5	5	UN651S	7100064NA		74-3A-65-A0-32-DF	Landscape	Unsupported	Unsupported	Unsupported	Unsupported	Calibrated
6	192.168.0.6	6	UN651S	6X.000341NA		8C-DF-9D-73-EE-A5	Landscape	Unsupported	Unsupported	Unsupported	Unsupported	Calibrated
7	192.168.0.7	7	UN651S	6X.000342NA		8C-DF-9D-73-EE-A4	Landscape	Unsupported	Unsupported	Unsupported	Unsupported	Calibrated
8	192.168.0.8	8	UN651S	6X.000282NA		8C-DF-9D-73-EE-07	Landscape	Unsupported	Unsupported	Unsupported	Unsupported	Calibrated
9	192.168.0.9	9	UN651S	6X.000350NA		8C-DF-9D-73-EE-82	Landscape	Unsupported	Unsupported	Unsupported	Unsupported	Calibrated

Calibration Target:





White Point:	10,000K (CIE xy0.273, 0.230)
Gamma:	2.20
Intensity:	650.0 cd/m ²
Contrast Ratio:	Monitor Default

Calibration Summary:

Display #	Uncalibrated Intensity	Uncalibrated White Point (CIE xy)	Uncalibrated Contrast Ratio	Maximum Calibrated Intensity	Date Measured	Operating Hours when Measured	Actual Calibrated Intensity	Actual Calibrated White Point (CIE xy)	Date Calibrated	Operating Hours when Calibrated	Calibrated Brightness Setting	Calibrated Color Settings	Uniformity Settings
1	787.7 cd/m ²	9.351 K (0.262, 0.268)	46.806:1	748.3 cd/m ²	10/30/2017 8:39 PM	116.5	652.2 cd/m ²	10.034 K (0.273, 0.230)	10/30/2017 8:51 PM	116.5	87.0%	LUT Rn252, G=230.	Not supported

Menus







File menu

-  **New Project** - Creates a new project and erases all of the current data.
-  **Open Project...** - Opens an existing Project file.
-  **Save Project** - Saves the current Project to a file.
-  **Save Project As...** - Saves the current project with a new file name.
-  **Generate ICC Display Profile...** - Generates an ICC Display Profile for the currently selected display.

Exit - Closes the application.

Additionally, up to the last 5 projects opened will be listed on the File menu for convenience.

Edit menu

-  **Preferences...** - Opens the **Preferences** dialog. See page 60.
-  **Layout Wizard...** - Opens the **Display Layout Configuration Wizard**. See page 42.
-  **Calibration Order...** - Opens the **Set Calibration Order** dialog. See page 50.
-  **Tile Matrix Wizard...** - Opens the **Tile Matrix Configuration Wizard**. See page 78.
-  **Calibration Target...** - Opens the **Edit Calibration Target** dialog. See page 56.
-  **Calibration Target Offset...** - Opens the **Calibration Target Offset** dialog. See page 80.
-  **Display Settings...** - Opens the **Display Settings** dialog. See page 82.

View menu

- Summary** - Opens or closes the **Summary** window. See page 100.
- Scale Main View** - Enables or disables scaling the main view's display rectangles from a fixed size to fit the window. See page 54.
- Connection** - Hides or shows the **Connection** panel. See page 74.
- Display Control** - Opens or closes the **Display Control** panel. See page 74.
- Calibration Target** - Hides or shows the **Calibration Target** panel. See page 77.
- Colorimeter** - Hides or shows the **Colorimeter** panel. See page 75.
- Display Measurements** - Hides or shows the **Display Measurements** panel. See page 76.
- Test Pattern** - Hides or shows the **Test Pattern** panel. See page 75.
- Reset/Restore** - Hides or shows the **Reset/Restore** panel. See page 76.

Tools menu

Verify Monitor Firmware... - Queries each display and checks if the internal firmware is compatible with *NEC Display Wall Calibrator*. Any displays that do not have the minimum level of firmware will be listed and must have the firmware updated before calibrating.

Verify RS232 COM Port... - Checks if the RS232 COM port adapter on the host system is capable of transmitting and receiving data to the displays correctly. Some adapters do not have a sufficient data buffer and will cause communications to fail under certain conditions.

Update Factory Color Calibration... - Updates the display's internal factory measured color reference, used by the SVE, with measurements taken from your color sensor. See Chapter 10 "Update Factory Color Calibration" on page 121.

Help menu



About... - Displays the **About** dialog box which shows the software version number.



Check for updates... - Contacts the Sharp NEC Display Solutions website and checks to see if a newer version of *NEC Display Wall Calibrator* is available. If a newer version is available, information about the version and download links will be shown. An Internet connection is required for this feature to operate.

User's Guide... - Opens the User's Guide PDF document.

Chapter 5

Quick Start Guide

1. Install Software

Install the *NEC Display Wall Calibrator* software on the host PC. The serial number, provided on either the CD-ROM cover or with the purchase, will be required to install the software.

2. Connect color sensor

Connect the color sensor to a USB port on the host PC and verify the drivers are installed correctly.

3. Warm up displays

Power-on each of the displays in the video wall. The displays should be warmed up for at least 30 minutes before calibrating.

4. Configure and connect displays

It is not necessary to connect the video output from the PC to any of the displays. The only connection to the displays will be either RS232 and/or LAN (Ethernet). Wireless LAN can also be used from the host PC if using a wireless access point or router.

See "Planning and Configuring a Wall Layout" on page 25 for detailed information about the various connection configurations.

5. Select the desired Calibration Method

In the Preferences dialog, on the Advanced panel, select the desired Calibration Method. The choice of selection will depend on the type of video wall application being used and the desired calibration results. See the ***Calibration Method Comparison*** section for detailed information about these options and choosing the best method for the display configuration.

6. Define Video Wall Layout and Connections

Use the "Layout Wizard" from the Edit menu to specify the number of displays, their layout, calibration order, and connection method.

If necessary modify the connection settings for any display by using the *Connection* panel.

7. Verify Communications

Test the communications to all the displays by clicking the *Verify All* button on the *Actions* panel. This will attempt to communicate with each display in the layout.

If there is an error in verifying communications with a display, see "Troubleshooting" on page 110.

As each display is successfully tested, its rectangle in the main window will change from Yellow to Cyan. Once all displays are verified, it is possible to continue on with the next stage of the calibration process.

8. Verify Monitor Firmware

Verify that each display has the correct firmware in order to correctly support using NEC Display Wall Calibrator. Select Verify Monitor Firmware from the Tools menu. Any displays that do not have supported firmware versions will need to be updated.

The latest firmware can be downloaded from the NEC website at: https://www.sharp-nec-displays.com/dl/en/dp_soft/pd_fm_update

9. Initialize Display Settings

Click the *Initialize All* button on the *Actions* panel to reset the color settings on each display to the default state.

10. Define the Calibration Target

Select *Calibration Target...* from the *Edit* menu, or click the *Edit...* button in the *Calibration Target* panel, to open the *Edit Calibration Target* dialog. The default values are suitable for most applications. If necessary for a particular application, custom settings for the method of Intensity adjustment, desired White Point, Gamma value, and Contrast Ratio can be selected.

11. Save

Save the project file.

12. Measure displays with default settings

Note: Steps 12 through 15 depends on the display model's capabilities, calibration Target settings, and the chosen calibration method. The steps given below are general guidelines.

If *Maximum Possible Matching* is selected as the *Intensity* adjustment method in the current *Calibration Target*, it will be necessary to measure the color characteristics of each display so the software can calculate how to match all of the displays. These measurements will determine the maximum possible Intensity that will give a color match to the displays.

In *Step 3 - Measure* on the *Actions* panel, click either **Selected** or **All** to start the measurement process. The user will be prompted to place the sensor on the screen of each display in turn. The display to place the sensor on will flash alternate red and green colors until the sensor has been positioned on the screen. Place the sensor flat against the center of the screen and hold it steady while applying the minimum force possible.

The software will then automatically measure the display characteristics, which will take about 30 seconds. When complete, the next display to be measured will flash and this process will continue until all displays are measured.

As each display is successfully measured, its rectangle in the main window will change from Cyan to Magenta.

13. Calibrate displays

In *Step 4 - Calibrate* on the *Actions* panel, click either **Selected** or **All** to start the calibration process. The user will be prompted to place the sensor on the screen of each display in turn. The display to place the sensor on will flash alternate red and green colors until the sensor has been positioned on the screen. The software will then automatically calibrate the display which will take 2 minutes or more.

When complete, the next display to be calibrated will flash and this process will continue until all displays are calibrated.

As each display is successfully calibrated, its rectangle in the main window will change from Magenta to Green.

14. Evaluate results

Once the calibration process is complete, the results can be visually evaluated by using the Evaluate Calibration feature. On Step 5 of the *Actions* panel, select the *Evaluate Calibration* checkbox.

Note: Since there is a slight color shift with screen viewing angle, be sure to evaluate the video wall from a distance and from directly in front.

The numerical results of the measurement and calibration process are available by selecting *Summary* from the *View* menu. This window shows the connection settings for all of the displays, including the model and serial number information for each display.

Important: If the displays do not match well when showing an analog video signal, this indicates that the analog video signal levels may need to be adjusted to compensate for variations that can cause color shifts between displays. See the **Analog Inputs - Important Notice** for more information.

15. Visual Trim (if necessary)

If there are any displays that are not able to be matched accurately enough using the automatic calibration, they can be visually adjusted using the *Visual Trim* feature.

16. Configure Tile Matrix (if necessary)

If the displays in the video wall are going to be showing a video source that is divided and expanded across multiple displays, using the internal Tile Matrix feature, the Tile Matrix Wizard can be used to easily configure the settings for all of the displays.

17. Save

Save the project file so it can be used in the future to re-calibrate the displays when necessary.

The Summary information can be printed or saved as a PDF file for reference.

Frequently Asked Questions

Configuration

Question: Can I use NEC Display Wall Calibrator to calibrate a single display?

Answer: Yes. Use the Layout Wizard to create a layout with a 1x1 video wall and calibrate as normal.

Question: How can I configure a video wall that is not rectangular in shape?

Answer: Create a layout with the maximum number of rows and columns of displays. Then disable the displays in the layout that are not part of the video wall. To disable a display, right click on the icon for the display in the main window and select **Disable**. It may be necessary to manually re-configure the Connection settings for some of the displays since the Layout Wizard will have assigned IP addresses or IDs sequentially for all displays, including the disabled ones.

Calibration

Question: How often will I need to use NEC Display Wall Calibrator to re-calibrate a video wall?

Answer: The time until the displays need to be re-calibrated will depend on many factors such as the environment and duration they are used, the age of the displays, the calibration Target settings used, and how critical the color matching requirements are. Newer displays will tend to drift more rapidly than displays that have been in use for several days or weeks. Typical re-calibration periods could be six months for most applications and as low as one month for color critical applications.

If calibrating using the SpectraView Engine (SVE), the display will automatically stabilize the display color allowing for longer intervals between calibrations. See "SpectraView Engine (SVE)" in the "Supported Display Monitors" table on page 8 for models that support this feature.

Question: If one of the displays in the video wall is replaced, will it be necessary to re-calibrate the entire video wall?

Answer: It depends on the particular type of calibration settings being used and the performance of the new display compared to the existing displays. If the new display is much brighter than the existing displays, then in most cases it is possible to only calibrate the new display in order to match the others - since it can be adjusted down in luminance to match the other displays.

However, if the new display is about the same or lower brightness as the existing displays, then the existing displays may need to be re-calibrated in order to match the new display since it may now be the dimmest display.

Also, the existing displays may have drifted since the last calibration so it may be necessary to re-calibrate all of the displays. Alternately, if re-calibrating the existing displays is not a suitable option, a new Target setting can be created by measuring the actual white point of one of the existing displays using the "Custom White Point dialog" on page 59, and using this new Target to calibrate the replacement display.

Question: Why can't I get all of the displays to match perfectly, and what can be done to improve the matching?

Answer: The displays may not all match perfectly due to several reasons, such as:

- The color and brightness uniformity of the screen is never perfect and will vary across the screen area. However, the color sensor is only measuring and adjusting the center of the screen.
- When evaluating displays visually, we tend to look at the joints where adjacent displays meet. The edges of the displays are typically most non-uniform.
- The color sensor used to measure the displays perceives color slightly differently than the human eye. Colors on two different displays that the sensor measures as being identical in value, may be visually different to the human eye.
- The color of the LCD displays will vary slightly with viewing angle. So when viewing a video wall, each display will be viewed from a different angle which causes color shifts.
- The colors on the LCD screen can be temporarily distorted by any pressure applied to the screen. Applying too much pressure to the color sensor during calibration can cause inaccurate color matching.

In order to try and improve the color matching between displays after they have all been calibrated, first try recalibrating the worst matching display(s). If this does not improve the matching, then use the *Visual Trim* feature to make minor changes to the display visually.

Chapter 7

Troubleshooting

Installation and Setup

Problem: Measure and Calibrate buttons are disabled.

Solution: The Measure and Calibrate buttons are disabled for any of the following reasons:

- No supported color sensor was detected.
- No supported display monitor was detected.
- All of the displays have not yet been Verified.

Hover the mouse cursor over the disabled button to show its tooltip. See "Action button ToolTips" on page 73.

Problem: *Verify Communications* operation fails.

Solution: Check that:

- Each display is correctly configured to use either the LAN or RS232 interface by confirming the EXTERNAL CONTROL setting on the OSD menu. See "EXTERNAL CONTROL setting" in the "Supported Display Monitors" table on page 8.
- The MONITOR ID is set correctly on the OSD and matches the value assigned in the software.

If using RS232:

- If using daisy-chaining, confirm that no other displays on the same chain have the same MONITOR ID.
- Make sure each display is connected via a NULL modem cable and that the correct IN or OUT socket on the display is used.
- Make sure no other application or process is using the specified COM port.

If using LAN:

- Make sure the IP address of each display is set correctly and that each display has a unique IP address.
- Make sure the IP address assigned to each display matches those assigned in the software.
- Make sure no other device on the LAN is assigned the same IP address.
- For older models, configuring the IP address via the OSD is not available and must be set using a web browser. The default IP address is 192.168.0.10. Please see "Assigning an IP address" on page 131 for instructions and "LAN setting by OSD" in the "Supported Display Monitors" table on page 8 for a list of displays that support configuring LAN settings in the OSD.
- Make sure the displays are on the same subnet as the host PC being used.
- Make sure there are no firewall settings or antivirus applications that may be preventing the application from accessing the LAN or blocking port 7142.

Calibration

Problem: When switching to different video inputs the displays no longer match.

Solution: Each video input can have its own settings for various controls, such as Brightness, Gamma Selection, Picture Mode, etc.

During calibration, the settings for the currently selected video input are automatically configured. However, if other video inputs are going to be used as well with the video wall, the settings for those inputs will need to be correctly configured to use the calibrated settings.

Use the **Calibration** panel on the **Display Settings** dialog to apply the calibration settings to other video inputs. See "Display Settings dialog - Video panel - Calibration settings" on page 87.

Problem: When showing the Calibrated Test Pattern the displays in the video wall match. However, when an analog video signal is shown they no longer match.

Solution: Differences in the analog video signal level between displays may cause the displays not to match.

The Auto-Setup operation should be performed on each display, which will measure the incoming analog video and automatically set the video level controls in the display.

This operation may need to be performed each time a new analog video signal is connected, or if a major change was made to the video wiring to the display, or a video amplifier or splitter was added to the video source.

Auto-Setup can be accessed from the OSD on each display, or by using the **Video** panel in the **Display Settings** dialog from the **Edit** menu.

Note: *This adjustment process requires specific patterns to be displayed on the video signal in order for the display to automatically adjust the video signal levels correctly. Failure to display the correct signal may result in the video levels being incorrectly set and the displays may not match in color when using an analog video source.*

Problem: "Error: No reply from the display" message is shown during the calibration when using a USB to RS232 adapter.

Solution: Certain models of USB to RS232 adapters may not function correctly with NEC Display Wall Calibrator and may cause an "Error: No reply from the display" message during the calibration process. The display will be detected correctly, but the calibration will fail at a certain point.

This issue is caused by an incompatibility with the USB to RS232 adapter and drivers that causes long messages sent to the display to not be transmitted correctly.

If an error is encountered, please check with the hardware vendor to see if newer device drivers are available. If this does not solve the issue, try using a different model of USB to RS232 adapter.

Try using the **Verify RS232 Com Port** function on the "Tools menu" on page 104 to verify correct operation.

Color Sensor

Problem: Software is unable to detect the X-Rite ColorMunki

Solution: If the X-Rite ColorMunki software is installed, it will prevent NEC Display Wall Calibrator from accessing the device even if the main ColorMunki application is not currently running.

If the ColorMunki software prior to version 1.1.0 is being used

- NEC Display Wall Calibrator will detect if the ColorMunki software is running and give the option of closing it automatically.
- To use the ColorMunki software again after NEC Display Wall Calibrator has closed it, the colormunki.exe application must be run from the Startup menu in Windows.

If the ColorMunki software version 1.1.0 or newer is being used:

- The ColorMunki Service in the Windows Control Panel > “X-Rite Device Services” must be turned off to allow NEC Display Wall Calibrator to access the device.
- To use the ColorMunki software again, the ColorMunki Service must be turned back on.

Problem: When calibrating or measuring a display, the software becomes stuck with the message “Detecting sensor on display”.

Solution: The software detects that the sensor is positioned on the correct display by flashing alternate red and green patterns on the display and taking measurements with the color sensor. If valid color measurements are not detected then the calibration or measurement will not proceed. If the color sensor is damaged or has become very inaccurate, it may not be able to detect the colors correctly. It may be necessary to replace the color sensor.

Problem: DataColor Spyder 3, 4, or 5 color sensor is not detected (Windows version only).

Solution: The device drivers may not be installed. Open the Windows device manager and locate the Spyder device. Select Update Drivers and provide the location of the drivers. The driver files are copied during installation to the following folders:

On 32 bit Windows:

- C:\Program Files\NEC Display Solutions\NEC Display Wall Calibrator\Drivers\Spyder3
- C:\Program Files\NEC Display Solutions\NEC Display Wall Calibrator\Drivers\Spyder4
- C:\Program Files\NEC Display Solutions\NEC Display Wall Calibrator\Drivers\Spyder5

On 64 bit Windows:

- C:\Program Files (x86)\NEC Display Solutions\NEC Display Wall Calibrator\Drivers\Spyder3
- C:\Program Files (x86)\NEC Display Solutions\NEC Display Wall Calibrator\Drivers\Spyder4
- C:\Program Files (x86)\NEC Display Solutions\NEC Display Wall Calibrator\Drivers\Spyder5

If the drivers are not installed in this location, reinstall NEC Display Wall Calibrator and make sure the option to install the Spyder drivers is selected.

Problem: Konica Minolta color sensor selection is disabled on the Preferences > Color Sensor > Sensor Type list and the sensor cannot be detected (Windows version only).

Solution: The Konica Minolta color sensor component option must be selected from the setup installer application. Reinstall the software and select the **Konica Minolta color sensor support** component. The USB drivers for the sensor must also be installed.

Chapter
8

Visual Trim function

The *Visual Trim* function allows minor adjustments to be made to the results of the calibration process, in order to improve the visual matching of the displays in the video wall if necessary. This feature can be used in cases where the automatic color sensor based calibration was not accurate enough, and some visual differences between displays can be seen with the human eye.

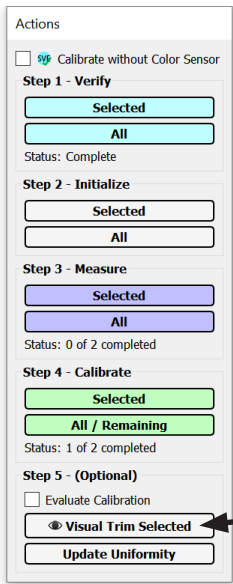

Once a display has been calibrated, the *Evaluate Calibration* checkbox and the *Visual Trim* button will be enabled in the *Actions* panel.

Note: It is best to evaluate screen matching when displaying a white screen on all displays. Select the **Evaluate Calibration** checkbox to show Calibrated White test patterns on all screens simultaneously.

Visual Trim button - Opens the *Visual Trim* dialog.

The white point and brightness of the display can be interactively adjusted using the various controls from within the *Visual Trim* dialog. The *Visual Trim* dialog is different depending on whether or not the display was calibrated using the SpectraView Engine (SVE).

On supported models calibrated using the SVE, the level of screen uniformity correction applied can be adjusted to improve the overall uniformity of the screen. Also, on some models, the color tint of the corners of the screen can be individually adjusted to improve color matching with adjacent displays in the video wall.

Visual Trim (calibrated without SpectraView Engine)

The Backlight Brightness slider adjusts the brightness of the LCD backlight instead of scaling the red, green and blue video levels. Note that large adjustments to the backlight brightness may take several minutes to stabilize. The range of adjustment using the backlight is more limited than using the RGB Luminance brightness control. Adjusting this control will impact the power used by the display.

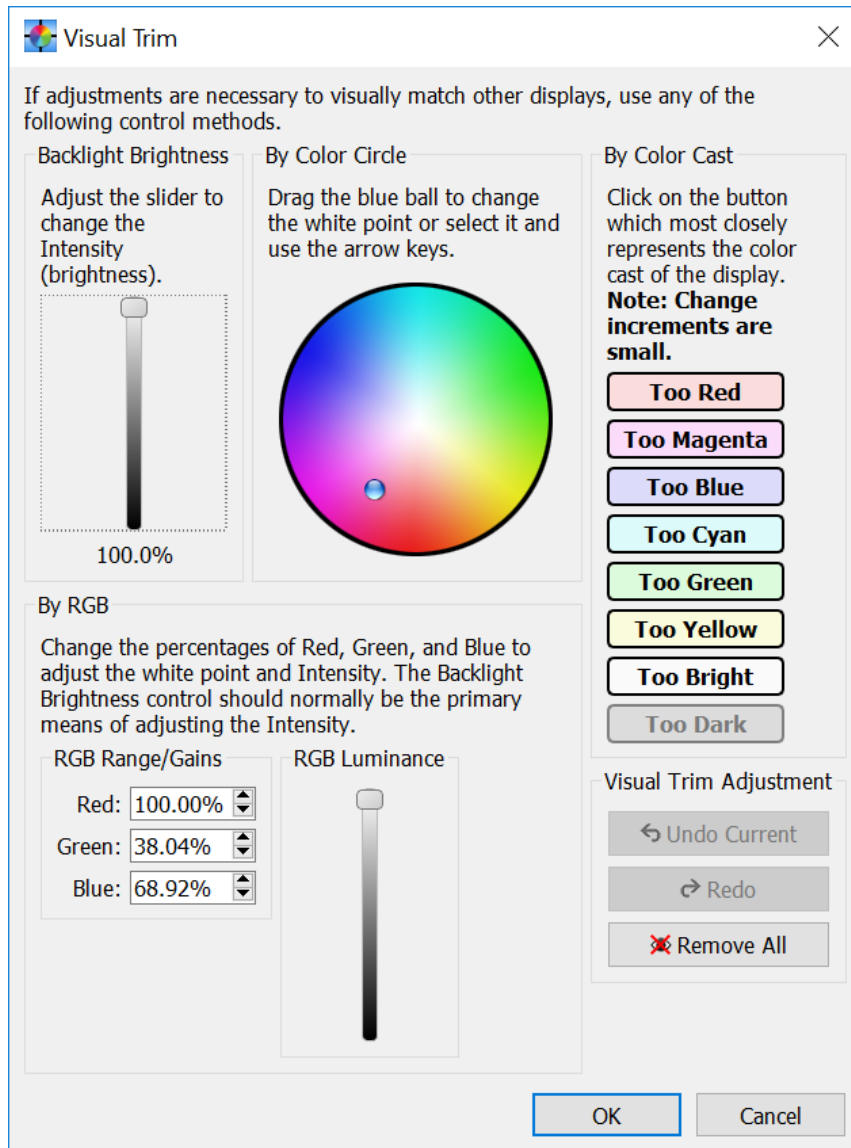

Three different types of controls are available, but they all accomplish the same function.

- **By Color Circle** - The color of display can be adjusted by dragging the blue ball control around the color circle. The color tint of the display will change towards the color under the ball position. The keyboard arrow keys can be used to move the ball if more precision is needed.
- **By Color Cast buttons** - Clicking the button that best represents the color cast on the display compared to others, will adjust the display to reduce that cast. Each single adjustment is small, so several may be necessary to make larger changes. Click the buttons multiple times in succession to make larger changes quickly.
- **By RGB Range/Gains percentage** - Adjusting these values changes the ratios of the red, green and blue on the display.

To quickly compare adjustments made since the dialog was opened, click the **Undo Current** button to remove the changes. Click **Redo** to re-apply the changes.

To remove a Visual Trim adjustment applied to the display, click the **Remove All** button under *Visual Trim Adjustment*.

Once the necessary adjustments have been made, click OK to update the display. The Visual Trim adjustment will be stored as part of the project until the next time the display is calibrated. The Visual Trim icon  is shown in the Display layout diagram for any displays that have a visual trim adjustment applied to the calibration.

Visual Trim (calibrated with SpectraView Engine)

Overall Screen Color correction

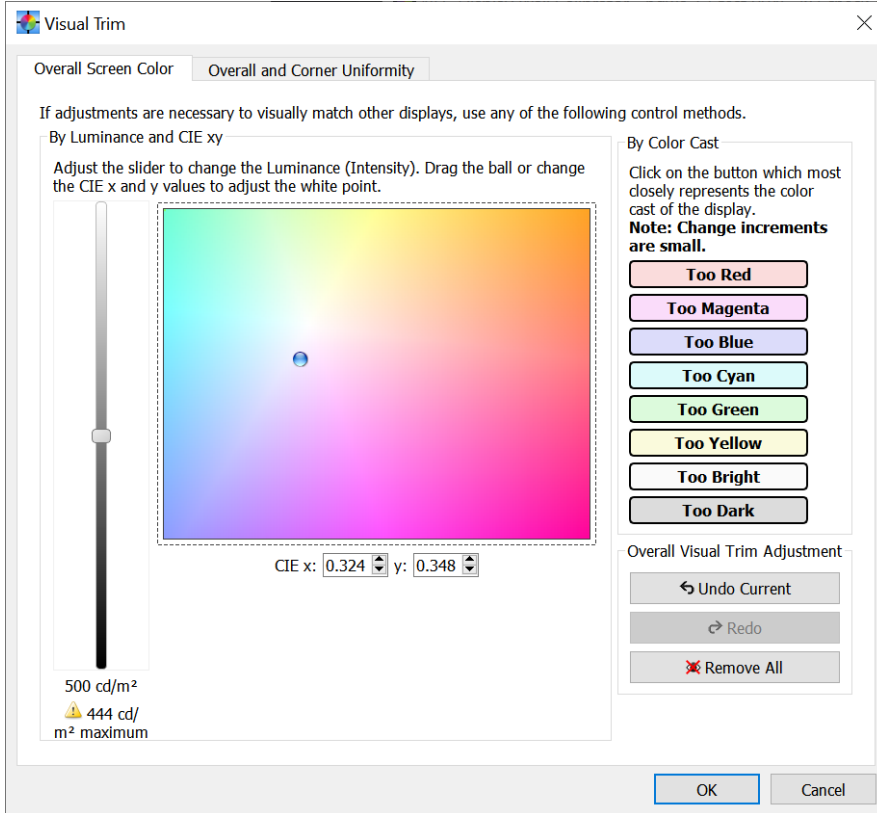

There are two different methods for performing the visual trim adjustment.

- **By Luminance and CIE xy**
 - Use the slider to adjust the Luminance (Intensity).
 - The color of display can be adjusted by dragging the blue ball control around the color field. The color tint of the display will change towards the color under the ball position. The keyboard arrow keys can be used to move the ball if more precision is needed. Alternatively, the color can be adjusted by directly inputting CIE **x** and **y** values.
- **By Color Cast buttons** - Clicking the button that best represents the color cast on the display compared to others, will adjust the display to reduce that cast. Each single adjustment is small, so several may be necessary to make larger changes. Click the buttons multiple times in succession to make larger changes quickly.

A warning icon and the message "Maximum" will be shown if the current Luminance setting results in the display's backlight reaching the maximum possible level. The screen luminance output will cannot be increased further.

Overall and Corner Uniformity correction

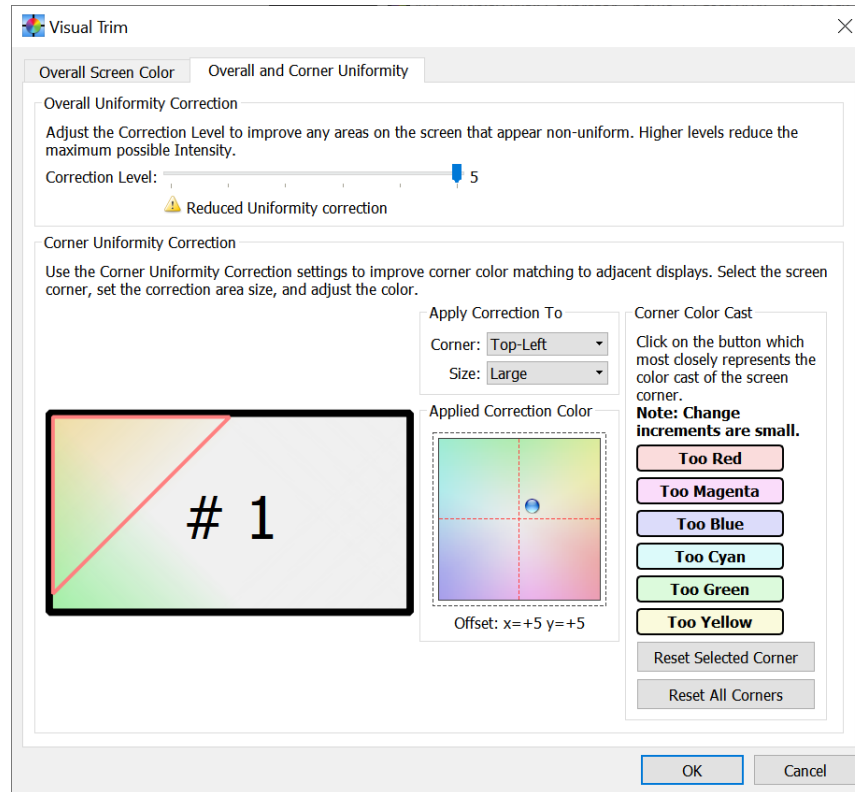

Use the **Uniformity Correction** slider to adjust the Correction Level to improve any areas on the screen that appear non-uniform. The lowest setting disables the Uniformity Correction entirely. Level 1 reduces any color unevenness across the screen but with the trade-off of reduced luminance evenness, especially around the edges of the screen. Higher levels of correction improve the luminance evenness across the screen, including around the edges.

A warning icon and message will be shown if the currently selected Uniformity Correction level cannot be achieved because the Luminance setting is too high. The display will automatically reduce the level of Uniformity Correction in order to achieve the desired Luminance level. In this case, lowering the Luminance (Intensity) will allow a higher level of Uniformity Correction to be applied.

On supported display models (see the "Corner Uniformity" column in the "Supported Display Monitors" table starting on page 8), if a screen corner has a color tint that prevents it from visually matching well with adjacent displays, the Corner Uniformity Correction controls can be used to improve this. Select the corner to be adjusted either by clicking on the display diagram or from the corner list. Next, click on the Applied Correction Color diagram or click the Corner Color Cast buttons to change the correction color applied to the selected corner. Use the Size list or click on the control in the display diagram to change the size of the corner area correction. If there are still areas of screen non-uniformity, then the "Update Uniformity Correction" function can be used to make further improvements. See Chapter 9 "Update Uniformity" on page 118.

Important: The Uniformity Correction functions of the display can only correct for non-uniformities across the screen which are not viewing angle dependent. It cannot correct for any areas that change depending on the viewing angle. Always evaluate the uniformity while viewing the screen directly.

To quickly compare adjustments made since the dialog was opened, click the **Undo Current** button to remove the changes. Click **Redo** to re-apply the changes.

To remove a Visual Trim adjustment applied to the display, click the **Remove All** button under *Visual Trim Adjustment*.

Once the necessary adjustments have been made, click OK to update the display. The Visual Trim adjustment will be stored as part of the project until the next time the display is calibrated. The Visual Trim icon  is shown in the display layout diagram for any displays that have a visual trim adjustment applied to the calibration.

Chapter 9

Update Uniformity

Screen uniformity is unique to each display and may change over time from factory production due to environmental and other factors, such as age and display orientation.

The Update Uniformity feature can be used, if necessary, to improve the effectiveness of the Uniformity Correction feature by enhancing the original factory screen uniformity measurements with measurements taken from your color sensor.

Info: See Appendix B **Figure 1** for a flowchart showing the recommended calibration procedure and steps for using this feature.

Access this feature by clicking on the “Update Uniformity” button on the Actions panel. It is only available if the selected display supports this feature (see “Update Uniformity Correction” column in the “Supported Display Monitors” table starting on page 8).

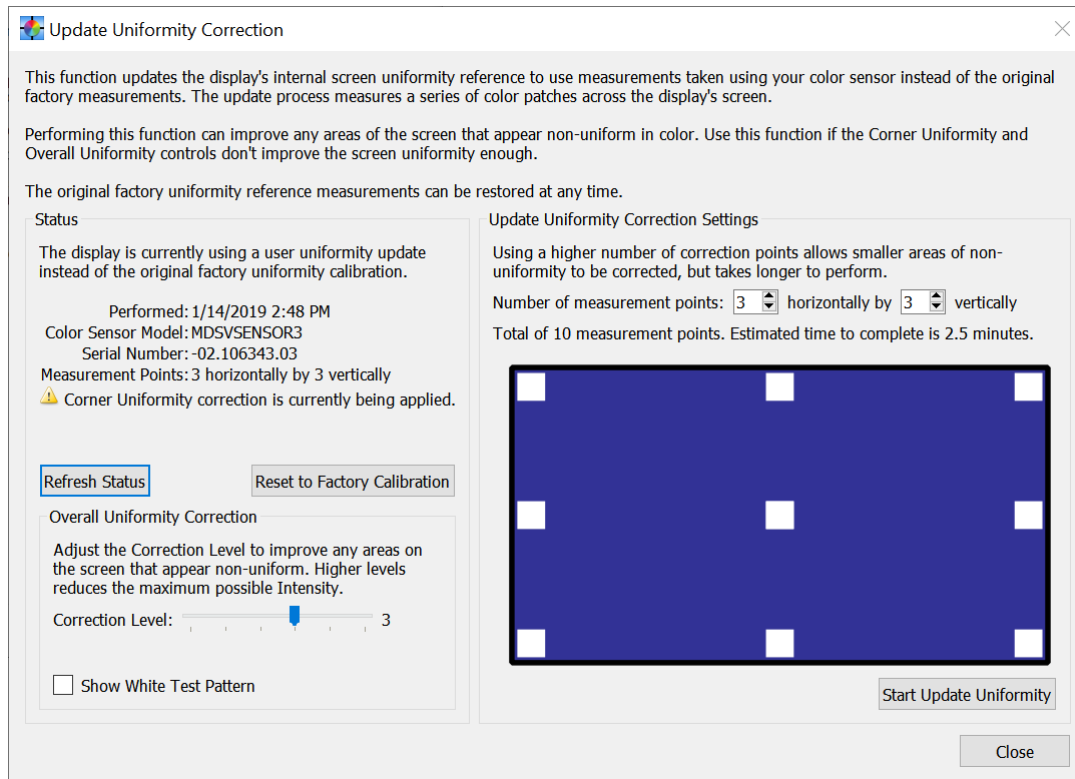

For display models that include the SVE and screen Uniformity Correction feature, each display was individually analyzed during factory production to measure the color and luminance uniformity across the entire screen. These measurements are stored in the display, and the SVE can create a Uniformity Correction to even out the screen uniformity.

This feature works by taking a series of measurements across the screen area using your color sensor. The display’s internal SVE analyzes these measurements and calculates a new uniformity correction, which is then used to enhance the uniformity correction applied to the screen. This updated correction is stored in the display.

The number of measurement points can be selected from between 3 and 10 points horizontally and vertically – up to a maximum of 100 points in total. Using more measurement points generally allows smaller areas of non-uniformity to be characterized and corrected but takes longer to perform.

Each display keeps track of which uniformity correction characterization set it is using (factory or user), the date and time when updated, which color sensor was used to take the measurements, and the number of measurement points taken.

How and when to use Update Uniformity:

1. If the display appears to have areas of non-uniformity, first check to see if there are any physical causes such as pressure applied to the screen from adjacent displays or the surrounding areas. Even slight pressure on the screen can cause significant uniformity problems. It may also help to allow displays to stabilize for several hours after being unpacked and mounted.
2. Next, use the Uniformity Level setting to try and reduce these areas by increasing the level of compensation. See Chapter 8 "Visual Trim function" on page 113.

Be aware that the current Intensity/Luminance setting impacts the effectiveness of the Uniformity Correction control. The display prioritizes the Intensity/Luminance over Uniformity Correction and reduces the effective level of uniformity correction as necessary to achieve the Intensity/Luminance setting. A warning icon and message appears when this occurs. If necessary, try lowering the Intensity setting to see if the uniformity improves.

If any of the corners of the screen appear to have a color non-uniformity with an overall color cast, first use the Corner Color Correction function to try and reduce these. See "Visual Trim (calibrated with SpectraView Engine)" on page 115.

3. If, after performing these steps, the display still appears to have non-uniform areas across the screen, use the Update Uniformity feature. Visually evaluate the areas of non-uniformity to be corrected to best estimate the number of correction points. In many cases, depending on the size and shape of the area(s) of non-uniformity, a smaller number of points than the maximum can be used. The visual representation of the display and measurement point locations can assist with this determination.

Click "Start Update Uniformity" to begin the measurement process. The display being measured guides the measurement point locations. Voice prompts also guide the measurement point locations if it is enabled. See "Preferences dialog - Voice Prompts" on page 70.

Once the measurement process completes, the display automatically updates the uniformity correction applied to the screen.

Important: The Uniformity Correction functions of the display can only correct for non-uniformities across the screen which are not viewing angle dependent. It cannot correct for any areas that change depending on the viewing angle. Always evaluate the uniformity while viewing the screen directly.

Status - This area shows which uniformity correction the display is currently using – either a user uniformity update or the original factory characterization. If a user update has been performed, the date and time performed, and the color sensor model and serial number used, as well as the number of horizontal and vertical measurement points taken are shown. This information is stored in each display and is updated by the software.

Refresh Status - Reads the status information from the display. Usually, the information is automatically synchronized.

Reset to Factory Calibration - Reverts the display to the original factory measurement-based color reference and uniformity characterization. This operation cannot be undone.

Important: Any changes made to the display using the Update Factory Color Calibration feature is also reset. If the display was previously calibrated, it may need to be re-calibrated. See Chapter 10 "Update Factory Color Calibration" on page 121.

Measurement Points - Sets the number of points across the screen to measure both vertically and horizontally. If the area of non-uniformity is larger and even in color shift, then a smaller number of measurement points can be used. Generally, a larger number of points results in a better correction but takes longer to perform. An estimate of the time it will take based on the current settings is shown.

Start Update Calibration - Starts the process of measuring each of the selected displays using the color sensor and updating their internal color reference. This button is disabled if the software does not detect a color sensor. If the displays were previously calibrated, they may need to be re-calibrated.

Chapter 10

Update Factory Color Calibration

For display models that include the SVE, each display has an individually set internal color calibration reference from which all color settings are derived. This internal reference is initially set during factory production of the display by very accurate color measurement equipment.

Info: See Appendix B **Figure 1** for a flowchart showing the recommended calibration procedure and steps for using this feature.

The “Update Factory Color Calibration” function allows this internal color reference used by the SVE to be quickly updated to use measurements taken from your color sensor thus overriding the factory measurements. This function is for supported models only, see the "Update Factory Color Calibration" column in the "Supported Display Monitors" table starting on page 8.

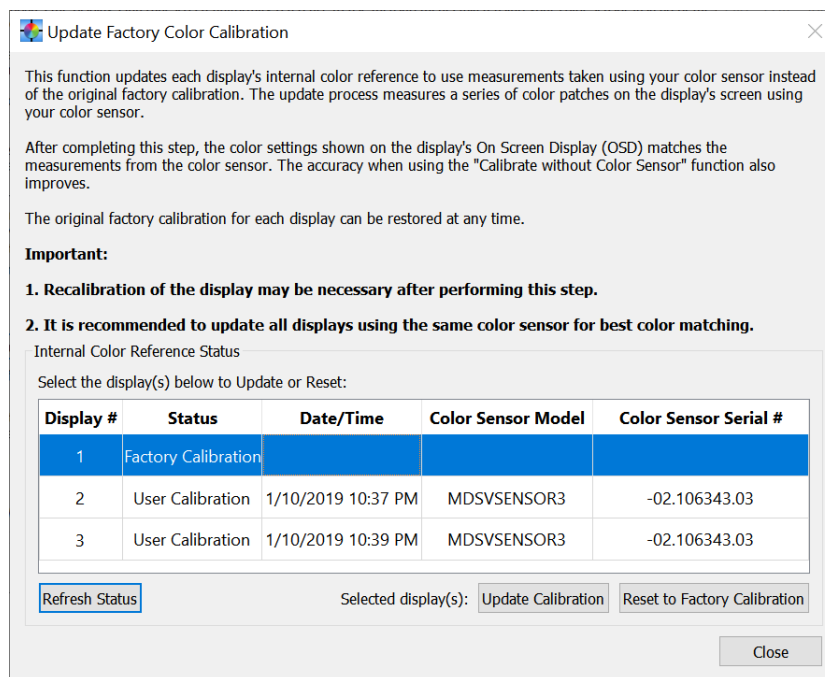

This function has several benefits:

- Matching OSD settings - The color related settings shown on the display's OSD such as white point and Luminance closely matches those measured by your color sensor.
- Updated Presets - By performing this single step, each color preset in the display is automatically updated to use the new color reference.
- Faster Calibration with a Color Sensor - It can lead to faster calibration times when calibrating using a color sensor since the initial state of the display closely matches measurements from the sensor.
- More Accurate calibration without a Color Sensor – When using the “Calibrate without Color Sensor” (see Chapter 11 "Calibrating Without a Color Sensor" on page 123) feature, each display uses its internal color reference and the SVE to derive the necessary color settings. Displays match much more closely if they have all been updated at the same time and with the same color sensor. This reduces the need to perform any manual Visual Trim based

adjustments afterward. It also means that different Targets can be selected and instantly set without the need to use the color sensor further.

Each display keeps track of which color reference it is using, the date and time when the internal color reference was updated, and which color sensor was used to take the measurements.

Important:

- Since there may be significant differences in the measurements from each color sensor compared to the original factory measurements, it is typically recommended to perform this function on all displays used in a video wall so that they all have the same color reference.
 - Always use the same color sensor for all displays.
 - It is essential to allow the displays at least 30 minutes to warm up before updating the calibration. Displays can be reset to use their original factory measurement-based color reference at any time.
-

Performing an Update Factory Color Calibration

The “Update Factory Color Calibration” function is accessed from the Tools menu and is only enabled if there is at least one display model in the current project that supports this function. (See the "Update Factory Color Calibration" column in the "Supported Display Monitors" table starting on page 8.)

The table shows the status of each display in the current project including if it is using a “User Calibration” or the original “Factory Calibration.” If a User Calibration was previously performed, the date and time and the color sensor model used, with its serial number, is shown. This information is stored in each display and is updated by the software.

Click on a row in the table to select that display. Multiple rows can be selected. The following operations can be performed:

- **Refresh Status** - Reads the status information from the displays and updates the table. Usually, the information shown in the table is automatically synchronized.
 - **Update Calibration** - Starts the process of measuring each of the selected displays using the color sensor and updating their internal color reference. This button is disabled if the software does not detect a color sensor. Any previously calibrated displays may need to be re-calibrated after performing this step. Place the color sensor at the center of the screen being updated when instructed. The process typically takes under 2 minutes per display to complete.
 - **Reset to Factory Calibration** - Reverts each of the selected displays to their original individual factory measurement-based color reference. This operation cannot be undone.
-

Important: Any changes made to the display using the Update Uniformity feature (see Chapter 9 "Update Uniformity" on page 118) are also reset. Any previously calibrated displays may need to be re-calibrated.

Calibrating Without a Color Sensor

For display models that feature the SVE technology, it is possible to set the display's color settings based entirely on the internal color reference settings used by the SVE without the need to use a color sensor to calibrate each display.

This may be useful in situations such as when:

- The displays must be quickly adjusted.
- Different calibration Target settings need to be evaluated quickly to determine suitability for the video wall application and environment.
- A color sensor is not available.
- The operator is skilled at quickly making minor visual based color adjustments.

i Info: See Appendix B **Figure 1** for a flowchart showing the recommended calibration procedure and steps for using this feature.

This method uses the SVE, combined with the factory measurements of each display, to quickly set the white point, Intensity, and grayscale correction. It allows for almost instant “calibration” of the displays to the selected Target settings - with all displays typically being updated in a few seconds. This means that different Target settings can be quickly evaluated without the need to individually recalibrate each display for each setting using a color sensor.

For display models that support the Update Factory Color Calibration feature, the internal color reference of the SVE can be updated - via a single measurement operation - to be based on your color sensor measurements instead of the original factory calibration. This “User Calibration” allows increased accuracy and matching between displays when using this calibration method, as well as other advantages outlined in “Update Factory Color Calibration” on page 121. See “Update Factory Color Calibration” in the “Supported Display Monitors” table on page 7 for models that support this feature.

i Info: To achieve the best results, it is highly recommended always to perform the “Update Factory Color Calibration” feature on all displays in the video wall at the same time and using the same color sensor. Do not use a mix of displays using the factory calibration and using the user calibration.

The accuracy of calibrating without a color sensor depends on many factors such as the Target settings and the age of each display. In some cases, it may be necessary to visually adjust some of the displays to improve the color matching by using the Visual Trim function (see Chapter 8 “Visual Trim function” on page 113). If the resulting color matching between displays is poor, then redo the “Update Factory Color Calibration” (if supported).

Performing a Calibrate Without Using a Color Sensor

To use this method, select the “Calibrate without Color Sensor” on the main Actions panel. This is only available if both calibration method options “Use LUTs” and “Use SpectraView Engine” have been selected, and the display model includes the SVE technology.

When selected, the calibration process steps are reduced to only Verify, Calibrate, and (optionally) Visual Trim.

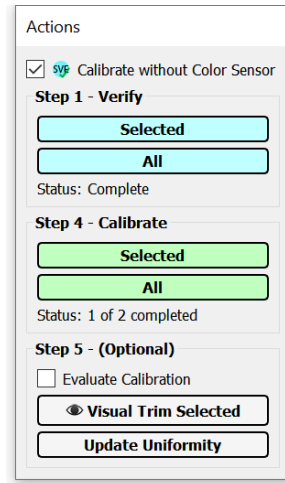

The recommended steps to use this method are:

1. Select the desired Target settings
2. Verify all the displays in the project using “Verify” in the Actions panel.
3. Select “Calibrate without Color Sensor” in the Actions panel.
4. “Calibrate” all displays using the Calibrate step.
5. Visually evaluate the resulting calibration using the “Evaluate Calibration” feature.

If the displays have good but not perfect color matching, then use the Visual Trim feature to fine-tune the matching by eye.

If the color matching is poor, use the “Update Factory Color Calibration” (if supported) on all the displays. Otherwise, change to the standard color sensor-based calibration method and calibrate each display or continue to use the Visual Trim feature to fine-tune the matching by eye further.

Note: If the current calibration Target’s Intensity is set to “Maximum Possible Matching” then all displays in the project must be calibrated simultaneously.

Chapter 12

Advanced Analog Adjustment function

Overview

The *Advanced Analog Adjustment* function is intended to assist with the manual adjustment of the analog video levels in cases where the automatic adjustment is not accurate enough.

The procedure involves the setting of a special LUT (Look Up Table) within the display, which will allow the analog video levels to be accurately set by making manual adjustments via the IR Remote while looking at the screen.

The process should take about 7 minutes or less per display depending on the experience level.

Once this process is repeated for all displays, the analog video levels between the displays should match closely, resulting in accurate color matching between displays when an analog video input is used.

Important: This procedure only adjusts the analog inputs of the display and sets the analog-to-digital conversion levels, which determine how analog video is converted to digital within the display. It does not adjust the digital portion of the video signal path. Therefore, it is very important to first calibrate the displays and make sure that the Calibrated White test patterns match satisfactorily between displays. This procedure should not be used to try and match displays that do not match when the Calibrated White test patterns are shown. In this case either re-calibrate the display(s), or use the Visual Trim feature.

Requirements

- The video input used must be analog and should use the same signal source, video resolution, cables, distribution amplifiers, etc., that will be used for the final installation.
- The video signal source must be capable of outputting a completely black signal and a full white signal.
- On some display models, the controls for adjusting the necessary settings will be available and enabled in the **Advanced** panel under the **Analog Video** panel in the **Display Settings**. The **Analog Offset Base (Bias)** Red, Green, and Blue slider controls can be used instead of using the OFFSET BASE 01-03 OSD settings, and the **Analog Gain** Red, Green, and Blue controls can be used instead of the GAIN 01-03 OSD settings respectively.
- On other models, the user must have access to each display's OSD (On Screen Display), either via a physical IR Remote, or by using the IR Remote emulation function in the Display Settings dialog. Using the IR Remote emulation can be slow to make many adjustments, so using a physical IR Remote is recommended if possible.
- Displays should be warmed up for at least 30 minutes before making these adjustments.

Adjustment steps

1. Connect the analog signal source and select the correct input on the display.
2. Input a 100% black video signal.
3. In the software, select the **Advanced** panel under the **Analog Video** panel in the Display Settings dialog and click the **Enable Expert OSD Mode** button. If the **Analog Offset Base** and **Analog Gain** slider controls are enabled, then the display model supports adjustment of the settings via software, and skip to step 6. Otherwise the controls must be adjusted via the OSD.
4. Use either an IR remote or the IR Remote emulation (see "Display Settings dialog - IR Remote panel" on page 90) to display the OSD. If the Expert Mode OSD has been successfully enabled, the OSD will show "EXPERT" in the top right corner. The Expert OSD menu is accessed by navigating to the right-most menu, then navigating one more step right.



EXPERT OSD menu

5. On the EXPERT OSD menu, navigate to the AUTO BIAS GAIN control.
6. In the software, click the **Black LUT** button to load the special LUT. This process will take less than 1 minute. When completed the screen may start to display some video noise - this is normal.
7. The aim of the next step is to adjust the red, green and blue Offset Base (Bias) settings correctly until the screen is full of bright white noise. If the slider controls are available, adjust the Analog Offset Base controls, otherwise the OFFSET BASE 01 (red), OFFSET BASE 02 (green), and OFFSET BASE 03 (blue) values on the OSD.

Use the IR Remote or IR Remote emulation feature to adjust the OFFSET BASE values up and down.

As the setting value nears the ideal setting, the color being adjusted will start to show as noise. The red, green, and blue noise will combine to make white noise.

The following table shows how the screen color will change as the OFFSET BASE values are adjusted:

SCREEN COLOR	OFFSET BASE 01 Value	OFFSET BASE 02 Value	OFFSET BASE 03 Value
Black	INCORRECT	INCORRECT	INCORRECT
Red Noise	OK	INCORRECT	INCORRECT
Green Noise	INCORRECT	OK	INCORRECT
Blue Noise	INCORRECT	INCORRECT	OK
Yellow Noise	OK	OK	INCORRECT
Cyan Noise	INCORRECT	OK	OK
Magenta Noise	OK	INCORRECT	OK
White Noise	OK	OK	OK

Note that screen may be very noisy and it may difficult to get a pure white screen. Adjust each control until as pure a white screen as possible can be obtained.

Important: Do not adjust the OFFSET 01, 02, or 03 settings.

i Info: If no noise is visible on the screen after adjusting the OFFSET BASE controls through the entire control ranges, check that a black signal is being input.

Examples:



Some red noise - OFFSET BASE 01 (Red) value almost correct, but 02 (Green) and 03 (Blue) are not close.



Yellow noise - OFFSET BASE 01 (Red) and 02 (Green) correct, but 03 (Blue) is not close.

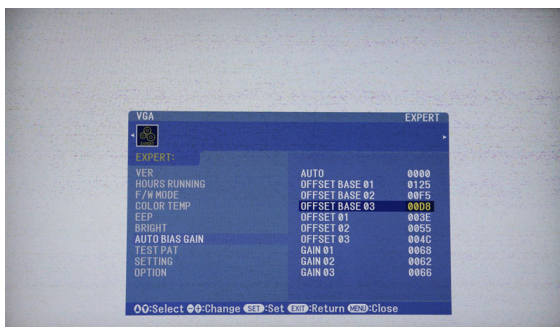

Bright white noise - OFFSET BASE 01 (Red), 02 (Green), and 03 (Blue) are correct.

8. Input a 100% white video signal from the analog source.
9. In the software, click the White LUT button to load the special LUT. This process will take less than 1 minute.
10. Adjust the Analog Gain slider controls is available, otherwise adjust the GAIN 01, 02, and 03 controls until the screen is full of bright white noise. Adjust each control until as pure a white screen as possible can be obtained. Use the IR Remote or IR Remote emulation feature to adjust the GAIN values up or down.

As the setting value nears the ideal setting, the color being adjusted will start to show as noise. The red, green, and blue noise will combine to make white noise.

If a color shows as dim but noiseless, it indicates the current setting value is too high, and should be reduced.

Hint 1: The edges of the screen may be very different from the center. Concentrate on the noise at the center of the screen.

Hint 2: In some cases it may be difficult to find the correct level when only adjusting one color. Try adjusting another color then go back to first color.

Hint 3: If it is not possible to locate the correct gain levels that show noise, check the source signal to make sure it is of sufficient voltage level. Proceed again in small increments.

Hint 4: Using the IR Remote may be faster than using the Analog Gain slider controls in the software due to the time it takes to update each control.

The following table shows how the screen color will change as the GAIN values are adjusted:

SCREEN COLOR	GAIN 01 Value	GAIN 02 Value	GAIN 03 Value
Black	INCORRECT	INCORRECT	INCORRECT
Gray	TOO HIGH	TOO HIGH	TOO HIGH
Red Noise	OK	INCORRECT	INCORRECT
Green Noise	INCORRECT	OK	INCORRECT
Blue Noise	INCORRECT	INCORRECT	OK
Yellow Noise	OK	OK	INCORRECT
Cyan Noise	INCORRECT	OK	OK
Magenta Noise	OK	INCORRECT	OK
White Noise	OK	OK	OK

11. In the software, click the Normal LUT button to restore the normal LUT. This process will take less than 1 minute.
12. Repeat for all other displays.
13. When complete, evaluate the adjustments using a white video signal from the analog source.

Chapter 13

Calibration Method Comparison

Overview

The software provides four methods of adjusting the displays to achieve the desired calibration target settings. The method used for the calibration is selected in the **Preferences** on the **Calibration Method** panel. The options are:

- **Use LUTs** - Uses LUTs (Look Up Tables) in the display to adjust the white point and grayscale correction. It uses an internally generated test pattern when measuring the display. Custom gamma curves and contrast ratios are possible. This method is slower than the Use RGB Gains method because there are more measurement steps, and the LUT must be transmitted to each display.
- **Use LUTs and SpectraView Engine** (*supported models only*) - Uses the advanced SVE combined with accurate factory measurements to quickly adjust the white point and grayscale correction. This method is faster and more flexible than using standard LUT only calibration. See "SpectraView Engine (SVE)" in the "Supported Display Monitors" table on page 8 for models that support this feature.
- **Calibrate Without Color Sensor** (*supported models only*) - This is only available if the calibration methods "Use LUTs and SpectraView Engine" have been selected and accessed from the Actions panel. It uses the advanced SVE combined with factory or user-based color measurements to quickly set the white point and grayscale correction without the need to use a color sensor. This method is fastest – taking only a few seconds to update all displays - and more flexible. See Chapter 11 "Calibrating Without a Color Sensor" on page 123.

For a list of supported displays, see "SpectraView Engine (SVE)" and "Update Factory Color Calibration" columns in the "Supported Display Monitors" table starting on page 8.

- **Use RGB Gains** - Uses the Red, Green and Blue Gain controls on the display to adjust the white point to the incoming video signal. A 100% white video signal must be displayed during the calibration. Custom gamma curves cannot be used, and only the fixed Gamma values of 2.2, 2.4, and Native are available. This method is faster than the Use LUTs method, but does not make any grayscale corrections.

The choice of Calibration Method to use will depend on the application and configuration of the video wall, as well as the level of calibration that is desired versus calibration speed. Refer to the following feature comparison table:

Feature	LUT Method	LUT with SVE	Calibrate Without Color Sensor	RGB Gain Method
<i>Full Grayscale Calibration</i>	Yes.	Yes, using accurate factory measurements		No. Do not use if accurate grayscale tracking is necessary.
<i>Uses internal test patterns for calibration</i>	Yes.	Yes.	N/A	No (requires 100% white signal source to be input.)
<i>Gamma Setting</i>	Custom Gamma Curves and variable gamma values.			2.2, 2.4, and Native Gamma only.
<i>Calibration Time</i>	3-5 minutes	1-2 minutes	5-15 seconds	2-3 minutes
<i>Manual adjustment after calibration</i>	Must use Wall Calibrator Software and project file.			Can use RGB Gain controls on the OSD.
<i>Contrast Ratio</i>	Specific Contrast Ratios are available (e.g. 300:1)			Not available.
<i>Calibrations for each video input</i>	All inputs share the same calibration.	Different inputs can have different calibrations by using Picture Modes.		Different inputs can have different calibrations.
<i>Analog Video Inputs</i>	Calibrates to internal test pattern.			Calibrates to the analog video signal level input, therefore compensating for video level differences.

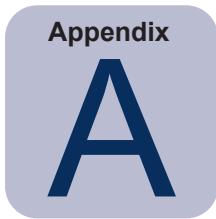

Assigning an IP address

Displays connected via LAN need to be assigned an IP address so they can be remotely accessed. Each display with a LAN interface has a default IP address of 192.168.0.10. This address must be changed in order to avoid conflicts when other displays are connected to the LAN. When the LAN RESET operation is performed on a display's OSD, the IP address will be reset to the default value.

Most display models support configuring the network settings directly via the OSD. The following steps can be skipped if the network settings can be configured using the OSD menu. See "LAN setting by OSD" in the "Supported Display Monitors" table on page 8 for models that support this feature.

Important: It is recommended to reset the power to the display after changing the LAN settings in order for the new settings to be recognized.

Setting the IP address via a web browser

The IP address of a display can be assigned by connecting a PC directly to the LAN port on the display, or via a LAN HUB while no other devices are connected. Note that a crossover LAN cable may be necessary on some display models if the PC is connected directly to the display.

If the PC being used to set the IP address of the display is not currently set to access the subnet that includes the display's default IP address, it will be necessary to temporarily modify the network settings in order to assign the PC a temporary IP address and subnet so the display can be accessed. Once the display has been configured the PC network settings should be restored.

Follow these steps:

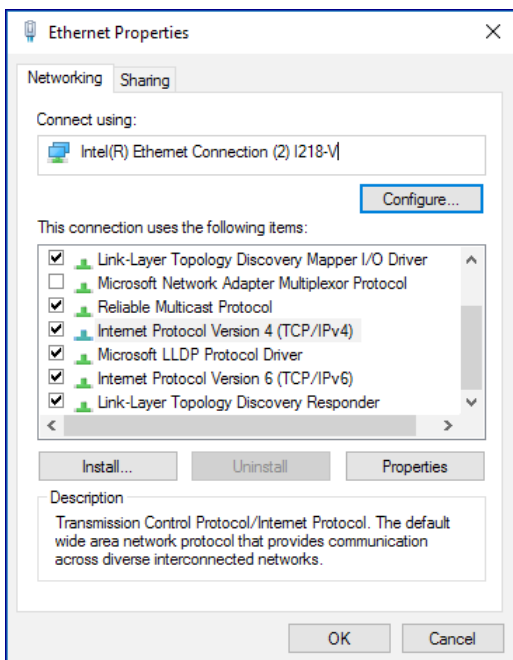

Open the *Network Settings properties* of the PC, select *Internet Protocol TCP/IP* in the list, and then click the *Properties* button.

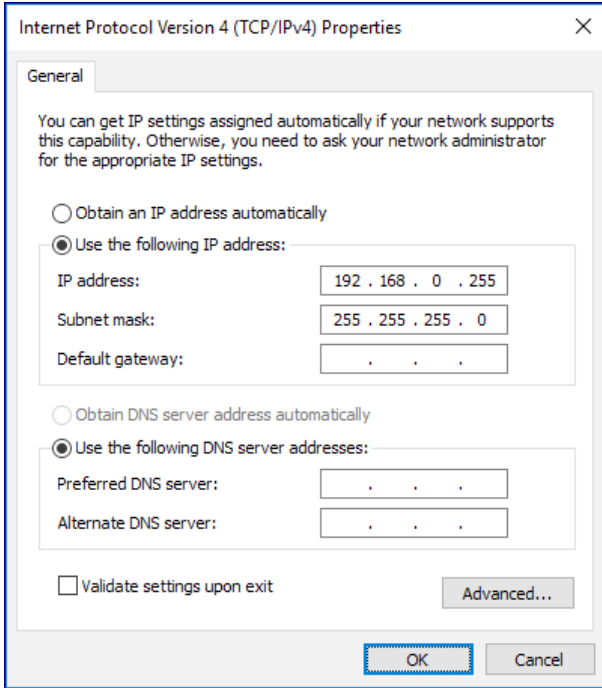

Next, enter a temporary IP address for the PC, such as 192.168.0.255 and a subnet mask of 255.255.255.0. Click **OK** and close the Network Settings.

Next, open a web browser and go to the URL of the display's web server by entering:

`http://192.168.0.10`

This should show the display's MONITOR NETWORK SETTINGS page.

If this page cannot be reached:

- Confirm that the display is powered on and connected to the PC either directly or via a HUB.
- Confirm that the IP address assigned to the display is at the default value, by performing a LAN RESET from the OSD on the display.
- Confirm that the EXTERNAL CONTROL setting on the OSD is set to LAN.
- Try refreshing the web page in the browser. It may take several refreshes before the display can be found.
- Check if any firewall software or settings on the PC could be preventing access to the display's IP address.
- Try resetting the power to the display.

Once the web page has appeared, the display's IP address and subnet mask can be entered and updated in the display. It is highly recommended to assign each display a static IP address so that the IP address will not be reassigned to another device if the network is reset.

 **Note:** Once the IP address is updated, the display will no longer be accessible from the current IP address.

Next, restore the original network settings on the PC.

Appendix B

Calibration Process Flowcharts - Recommended Procedures

Figure 1: Recommended calibration procedure for advanced SpectraView Engine models

This flowchart outlines the recommended basic steps for calibrating SpectraView Engine based display models that support the **Corner Uniformity**, **Update Factory Color Calibration**, and **Update Uniformity** functions. For display model support of these functions, see "Supported Display Monitors" on page 8 or the "Summary window" in the software.

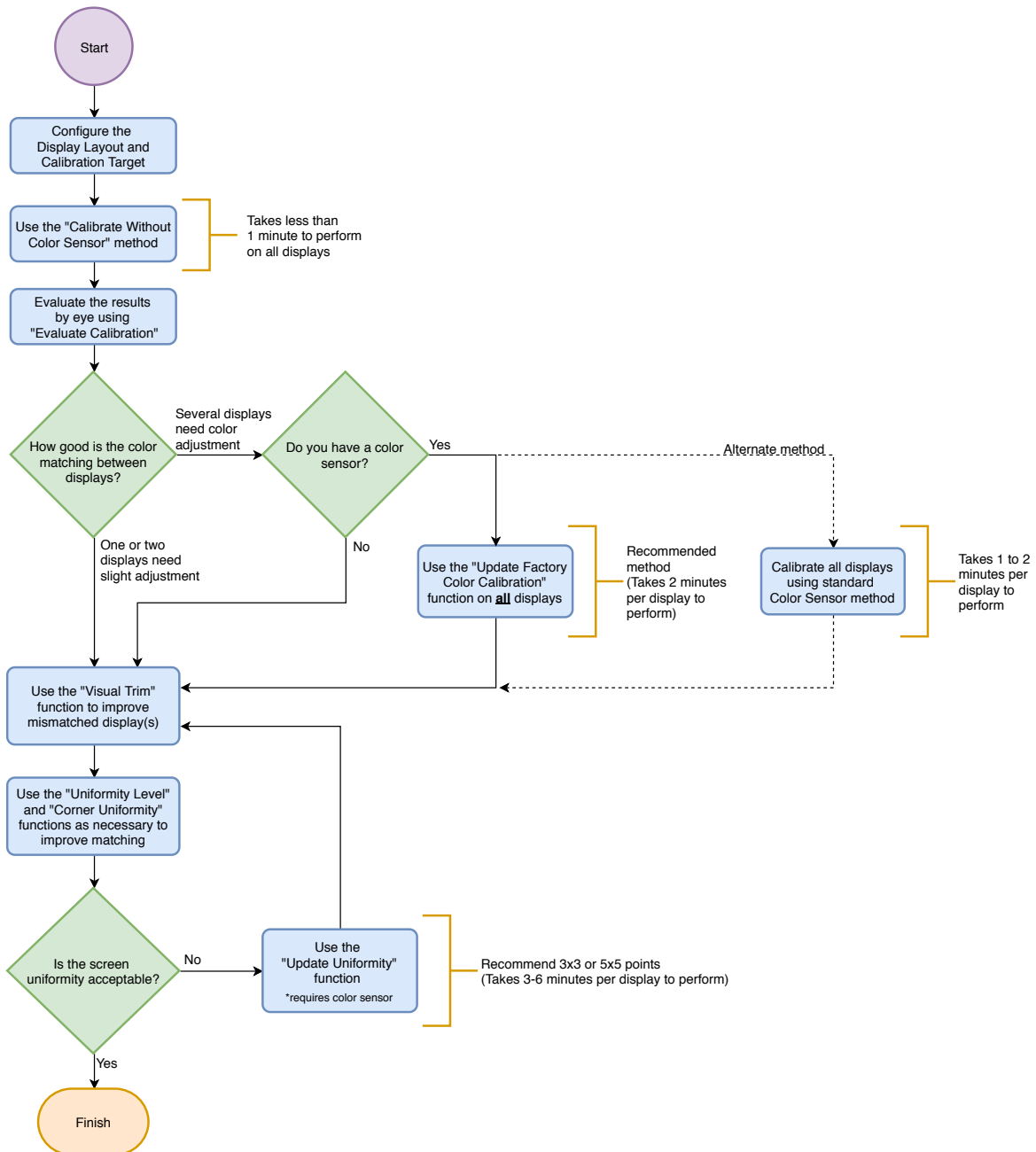

Figure 2: Recommended calibration procedure for SpectraView Engine models

This flowchart outlines the recommended basic steps for calibrating SpectraView Engine based display models that do not support the **Corner Uniformity**, **Update Factory Color Calibration**, and **Update Uniformity** functions. For SpectraView Engine equipped display models, see "Supported Display Monitors" on page 8 or the "Summary window" in the software.

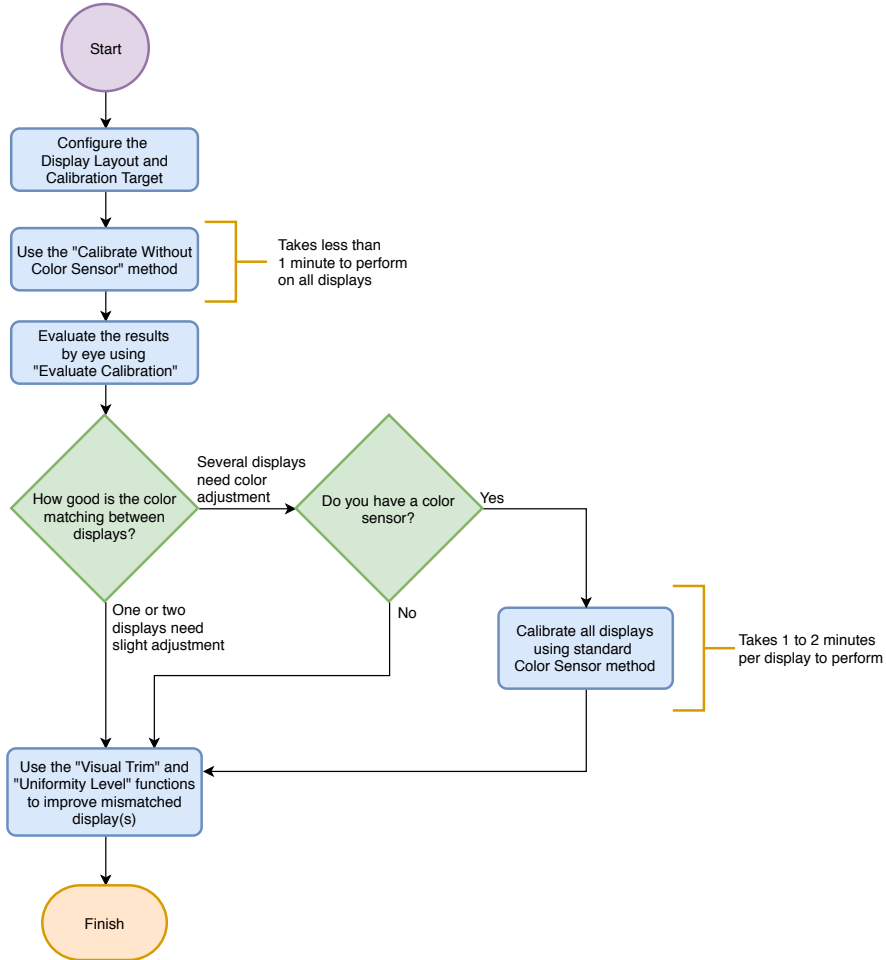
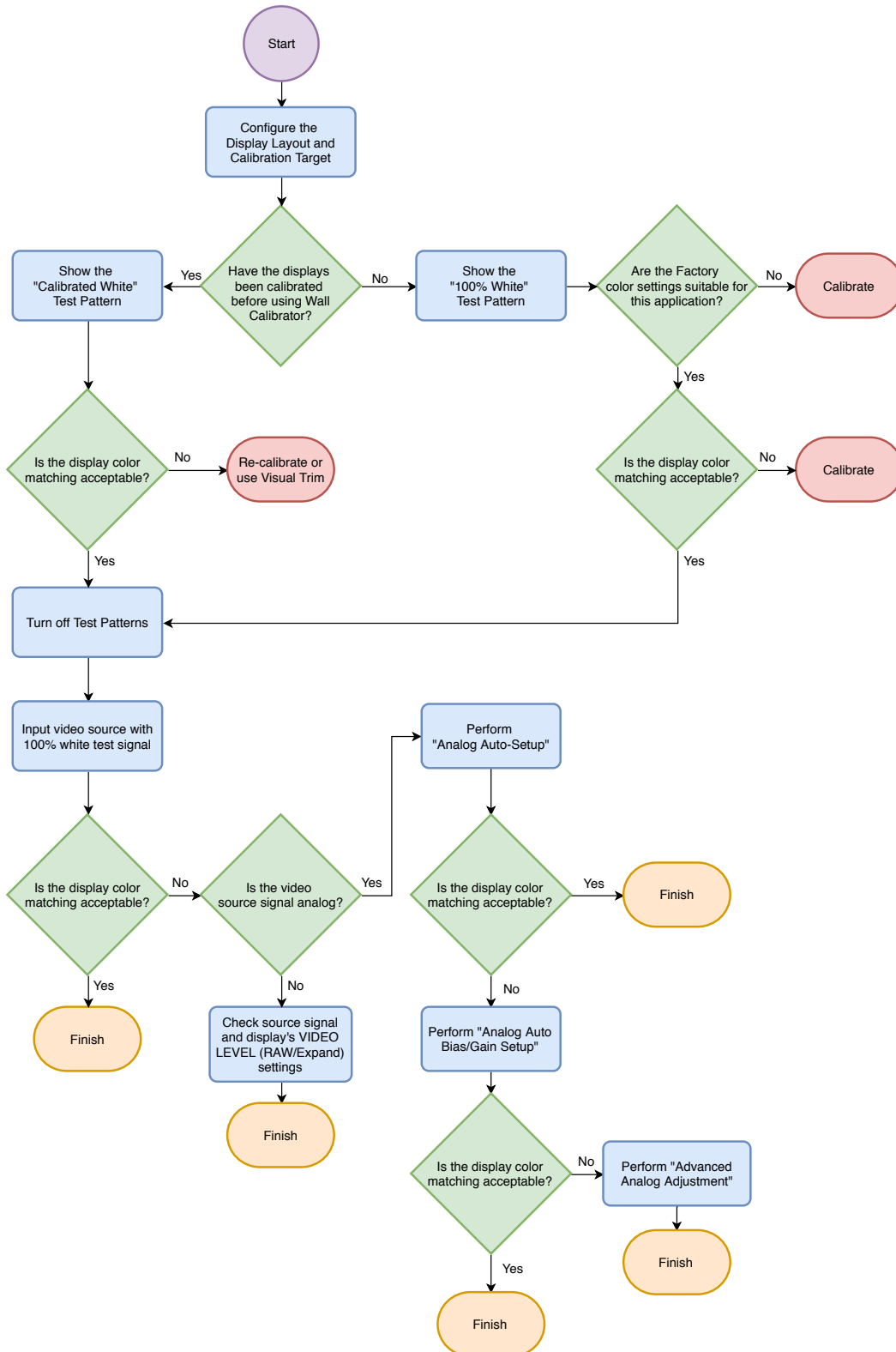
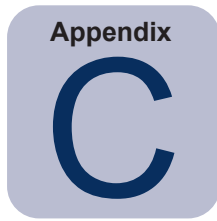

Figure 3: Overall calibration determination for displays and analog video inputs

The following flowchart outlines the basic steps in determining if the displays should be re-calibrated and which additional steps to perform if the input video signal is analog. See Chapter 12 "Advanced Analog Adjustment function" on page 125 function.





Glossary

Achromatic – Neutral in color (having no hue).

Additive Primaries – Red, green, and blue light that when combined in different relative intensities produces different colors. (See also Subtractive Primaries)

Backlight – the internal light source for a Liquid Crystal Display, such as fluorescent lamps or array of LEDs (Light Emitting Diodes).

Blackbody – A hypothetical object that absorbs all incident radiation, thus any radiation (e.g. light) coming from a blackbody must be emitted from it and not reflected.

Blackbody Radiator Locus – The curve formed when the color of light radiated from a blackbody is plotted at different temperatures on a color space such as CIE xyY.

Black Level – The luminance or “brightness” of black when displayed on the screen.

Calibration – The process of bringing a device such as a display monitor to an absolute standard to ensure consistency over time and with other similarly calibrated devices.

Candelas (cd) – An international unit of light intensity. Luminance can be described in units of Candelas per meter squared (cd/m^2) but is often referred to as just Candelas or Nits for sake of brevity.

CCFL – Cold cathode fluorescent lamp used for the backlight on LCD display panels.

CIE – The Commission Internationale d’Eclairage (International Commission on Illumination). An organization that sets many of the standards used in color and color measurement.

CIE uv chromaticity coordinates – Coordinates in the CIE uv color space which are derived directly from CIE xyY color space. CIE uv is more perceptually uniform than CIE xy.

CIE xy chromaticity coordinates – Coordinates in the CIE xyY color space representing color independent of luminance.

CIE xyY – A standard color space in which the Y component represents luminance. The x and y components represent color.

Color Gamut – (See Gamut)

Colorimeter – An optical measurement device used to measure color that responds to light by separating it into red, green, and blue components.

Color Temperature – The color of light given off by an object, known as a blackbody, as it is heated to a given temperature in degrees Kelvin. Low color temperatures such as 5000K are reddish, whilst higher color temperatures such as 9300K are bluish. A color temperature of 6500K is considered to be “neutral” white.

COM Port – The original name of the serial port interface on IBM PC-compatible computers.

Contrast Ratio – The ratio of the white luminance (Intensity) and black luminance (Black Level) of the display.

Correlated Color Temperature – The closest matching color, expressed in Kelvin, of a white point that does not lie

exactly on the blackbody locus.

D Illuminants – CIE Daylight Standard Illuminants based on approximating daylight. The subscript denotes the correlated color temperature of the illuminant. For example, D50 has a correlated color temperature of 5000K.

Delta-E ($\Delta-E$) – A measurement of how different two colors are to each other. In NEC Display Wall Calibrator, Delta-E values are derived by calculating the distance between two colors in Lab color space using the CIE 94 formula. A Delta-E value of 1 indicates a just perceptual difference between two colors.

Delta-uv ($\Delta-uv$) – A measure of how different two colors are, irrespective of luminance. In NEC Display Wall Calibrator Delta-uv values are used to indicate how far a white point is from the blackbody locus. CIE uv color space is used instead of CIE xy because it is more perceptually uniform or linear.

Device Gamut – The range of colors that a device can produce.

DICOM – Digital Imaging and Communications in Medicine.

Foot Lamberts (fL) – A unit of luminance. One foot Lambert is equal to 1 Candela per meter squared divided by $10.76/\pi$ (approximately 3.43).

Gamma – The relationship between the input video signal to a display monitor and the screen output luminance. Typically the screen luminance follows a mathematical power function of the input video signal, the exponent of which is called the gamma.

Gamut – The range of colors that can be reproduced on a particular device such as a monitor or printer, or that can be distinguished by a sensing device such as a scanner or the human eye.

Hue – The basic attribute of color such as red, green, yellow, blue or purple.

Intensity – Intensity specifies the luminance or brightness of white when displayed on the screen.

IP – Internet Protocol.

Kelvin – An absolute temperature scale denoted by K. Zero Kelvin (0K) is equivalent to -273° Celsius.

Lab – (See CIE Lab)

LAN – Local Area Network

LCD – Liquid Crystal Display.

Luminance – A measure of the brightness or intensity of light, usually expressed in units of Candelas per meter squared (cd/m^2) or foot Lamberts.

Look Up Table (LUT) – A table used to translate input values to output values. NEC Display Wall Calibrator displays use 10 bit internal LUTs to apply Gamma corrections and Tone Response Curves.

Native state – Without any kind of correction or calibration applied.

Nit – A unit of luminance equal to Candelas per meter squared (cd/m^2).

OSD – On Screen Display.

RS232 - Recommended Standard 232 is a standard for serial binary data signals.

Saturation – An expression of the amount a color deviates from being achromatic (neutral in color, such as gray). For example, red is a saturated color, while pink is less saturated, and white has no saturation.

SpectraView Engine (SVE) – The NEC custom designed color processor engine internal to the display. See "SpectraView Engine (SVE)" the "Supported Display Monitors" table on page 8 for models that support this feature.

Subnet – A subnetwork, or subnet, describes networked computers and devices that have a common, designated IP address routing prefix.

TCP/IP – Transmission Control Protocol / Internet Protocol.

Tone Response Curve – A graph representing the relationship between the input and output of a system or device. In NEC Display Wall Calibrator, Tone Response Curves represent the relationship between the intensity of a color within an application and the light intensity displayed on the monitor.

USB – Universal Serial Bus. A communication bus used to connect up to 127 devices such as keyboards, mice, scanners, color sensors, etc.

White point – Specifies the color of pure “white” on a display, usually as a Color Temperature expressed in Kelvin or as CIE xy chromaticity coordinates.

NEC

Copyright © 2021 Sharp NEC Display Solutions, Ltd. All rights reserved.

USA and Canada: www.sharpnecdisplays.us

Europe: www.sharpnecdisplays.eu

Asia Pacific: www.sharp-nec-displays.com/ap

Australia: www.nec.com.au